



# User Manual

Congratulations on the purchase of your new T-Mobile Shadow.

**Please Read Before Proceeding.**

**THIS PHONE IS NOT FULLY CHARGED WHEN YOU TAKE IT OUT OF THE BOX.**

**DO NOT REMOVE THE BATTERY PACK WHEN THE PHONE IS CHARGING.**

**YOUR WARRANTY IS INVALIDATED IF YOU OPEN OR TAMPER WITH THE PHONE'S OUTER CASING.**

**PRIVACY RESTRICTIONS**

Some countries require full disclosure of recorded telephone conversations, and stipulate that you must inform the person with whom you are speaking that the conversation is being recorded. Always obey the relevant laws and regulations of your country when using the recording feature of your phone.

**COPYRIGHT INFORMATION**

Copyright © 2007 T-Mobile. All Rights Reserved.

T-Mobile, HotSpot and the HotSpot design are federally registered trademarks, and the color magenta is a trademark, and t-zones is a service mark, of Deutsche Telekom AG. Shadow is a trademark, myFaves and the myFaves design are service marks, of T-Mobile USA, Inc.

Microsoft, MS-DOS, Windows, Windows NT, Windows Server, Windows Mobile, Windows XP, Windows Vista, ActiveSync, Windows Mobile Device Center, Internet Explorer, Windows Live, MSN, Hotmail, Outlook, Excel, PowerPoint, Word, and Windows Media are either registered trademarks or trademarks of Microsoft Corporation in the United States and/or other countries.

Bluetooth and the Bluetooth logo are trademarks owned by Bluetooth SIG, Inc.

Wi-Fi is a registered trademark of the Wireless Fidelity Alliance, Inc.

microSD is a trademark of SD Card Association.

Java, J2ME and all other Java-based marks are trademarks or registered trademarks of Sun Microsystems, Inc. in the United States and other countries.

Copyright © 2007, Adobe Systems Incorporated.

Copyright © 2007, Macromedia Netherlands, B.V.

Macromedia, Flash, Macromedia Flash, Macromedia Flash Lite and Reader are trademarks and/or registered trademarks of Macromedia Netherlands, B.V. or Adobe Systems Incorporated.

Copyright © 2007, JATAAYU SOFTWARE (P) LTD. All Rights Reserved.

Copyright © 2007, Dilithium Networks, Inc. All Rights Reserved.

ArcSoft MMS Composer™ Copyright © 2003-2007, ArcSoft, Inc. and its licensors. All Rights Reserved. ArcSoft and the ArcSoft logo are registered trademarks of ArcSoft, Inc. in the United States and/or other countries.

Licensed by QUALCOMM Incorporated under one or more of the following patents:

4,901,307 ; 5,490,165 ; 5,056,109 ; 5,504,773 ; 5,101,501 ; 5,778,338 ; 5,506,865  
5,109,390 ; 5,511,073 ; 5,228,054 ; 5,535,239 ; 5,710,784 ; 5,267,261 ; 5,544,196  
5,267,262 ; 5,568,483 ; 5,337,338 ; 5,659,569 ; 5,600,754 ; 5,414,796 ; 5,657,420  
5,416,797

All other company, product and service names mentioned herein are trademarks, registered trademarks or service marks of their respective owners.

T-Mobile shall not be liable for technical or editorial errors or omissions contained herein, nor for incidental or consequential damages resulting from furnishing this material. The information is provided "as is" without warranty of any kind and is subject to change without notice. T-Mobile also reserves the right to revise the content of this document at any time without prior notice.

No part of this document may be reproduced or transmitted in any form or by any means, electronic or mechanical, including photocopying, recording or storing in a retrieval system, or translated into any language in any form without prior written permission of T-Mobile.

## Important Health Information and Safety Precautions

When using this product, the safety precautions below must be taken to avoid possible legal liabilities and damages. Retain and follow all product safety and operating instructions. Observe all warnings in the operating instructions on the product.

To reduce the risk of bodily injury, electric shock, fire, and damage to the equipment, observe the following precautions.

### ELECTRICAL SAFETY

This product is intended for use when supplied with power from the designated battery or power supply unit. Other usage may be dangerous and will invalidate any approval given to this product.

### SAFETY PRECAUTIONS FOR PROPER GROUNDING INSTALLATION

**CAUTION:** Connecting to improperly grounded equipment can result in an electric shock to your device.

This product equipped with a USB Cable for connecting with desk-top or notebook computer. Be sure your computer is properly grounded (earthed) before connecting this product to the computer. The power supply cord of a desktop or notebook computer has an equipment-grounding conductor and a grounding plug. The plug must be plugged into an appropriate outlet which is properly installed and grounded in accordance with all local codes and ordinances.

### SAFETY PRECAUTIONS FOR POWER SUPPLY UNIT

- **Use the correct external power source**

A product should be operated only from the type of power source indicated on the electrical ratings label. If you are not sure of the type of power source required, consult your authorised service provider or local power company. For a product that operates from battery power or other sources, refer to the operating instructions that are included with the product.

- **Handle battery packs carefully**

This product contains a Li-ion battery. There is a risk of fire and burns if the battery pack is handled improperly. Do not attempt to open or service the battery pack. Do not disassemble, crush, puncture, short external contacts or circuits, dispose of in fire or water, or expose a battery pack to temperatures higher than **140°F**.



**WARNING:** DANGER OF EXPLOSION IF BATTERY IS INCORRECTLY REPLACED. TO REDUCE RISK OF FIRE OR BURNS, DO NOT DISASSEMBLE, CRUSH, PUNCTURE, SHORT EXTERNAL CONTACTS, EXPOSE TO TEMPERATURE ABOVE 140°F, OR DISPOSE OF IN FIRE OR WATER. REPLACE ONLY WITH SPECIFIED BATTERIES. RECYCLE OR DISPOSE OF USED BATTERIES ACCORDING TO THE LOCAL REGULATIONS OR REFERENCE GUIDE SUPPLIED WITH YOUR PRODUCT.



- **Take extra precautions**
  - Keep the battery or device dry and away from water or any liquid as it may cause a short circuit.
  - Keep metal objects away so they don't come in contact with the battery or its connectors as it may lead to short circuit during operation.
  - Do not use a battery that appears damaged, deformed, or discolored, or the one that has any rust on its casing, overheats, or emits a foul odor.
  - Always keep the battery out of the reach of babies and small children, to avoid swallowing of the battery. Consult the doctor immediately if the battery is swallowed.
  - If the battery leaks:
    - Do not allow the leaking fluid to come in contact with skin or clothing. If already in contact, flush the affected area immediately with clean water and seek medical advice.
    - Do not allow the leaking fluid to come in contact with eyes. If already in contact, DO NOT rub; rinse with clean water immediately and seek medical advice.
    - Take extra precautions to keep a leaking battery away from fire as there is a danger of ignition or explosion.
  - Communicate the appropriate steps immediately in case a hazard occurs.

### **SAFETY PRECAUTIONS FOR DIRECT SUNLIGHT**

Keep this product away from excessive moisture and extreme temperatures. Do not leave the product or its battery inside a vehicle or in places where the temperature may exceed **140°F**, such as on a car dashboard, window sill, or behind a glass that is exposed to direct sunlight or strong ultraviolet light for extended periods of time. This may damage the product, overheat the battery, or pose a risk to the vehicle.

## PREVENTION OF HEARING LOSS



**CAUTION:** Permanent hearing loss may occur if earphones or headphones are used at high volume for prolonged periods of time.

## SAFETY IN AIRCRAFT

Due to the possible interference caused by this product to an aircraft's navigation system and its communications network, using this device's phone function on board an airplane is against the law in most countries. If you want to use this device when on board an aircraft, remember to turn off the phone by switching to Flight Mode.

## ENVIRONMENTAL RESTRICTIONS

Do not use this product in gas stations, fuel depots, chemical plants or where blasting operations are in progress, or in potentially explosive atmospheres such as fuelling areas, fuel storehouses, below deck on boats, fuel or chemical transfer or storage facilities, and areas where the air contains chemicals or particles, such as grain, dust, or metal powders. Please be aware that sparks in such areas could cause an explosion or fire resulting in bodily injury or even death.

## EXPLOSIVE ATMOSPHERES

When in any area with a potentially explosive atmosphere or where flammable materials exist, the product should be turned off and the user should obey all signs and instructions. Sparks in such areas could cause an explosion or fire resulting in bodily injury or even death. Users are advised not to use the equipment at refueling points such as service or gas stations, and are reminded of the need to observe restrictions on the use of radio equipment in fuel depots, chemical plants, or where blasting operations are in progress. Areas with a potentially explosive atmosphere are often, but not always, clearly marked. These include fueling areas, below deck on boats, fuel or chemical transfer or storage facilities, and areas where the air contains chemicals or particles, such as grain, dust, or metal powders.

## ROAD SAFETY

In some states or local jurisdictions, vehicle drivers in motion are not permitted to use telephony services with handheld devices, except in the case of emergency. In some countries outside the US, using hands-free devices as an alternative is allowed.

## **SAFETY PRECAUTIONS FOR RF EXPOSURE**

- Avoid using your device near metal structures (for example, the steel frame of a building).
- Avoid using your device near strong electromagnetic sources, such as microwave ovens, sound speakers, TV and radio.
- Use only original manufacturer-approved accessories, or accessories that do not contain any metal.
- Use of non-original manufacturer-approved accessories may violate your local RF exposure guidelines and should be avoided.

## **INTERFERENCE WITH MEDICAL EQUIPMENT**

This product may cause medical equipment to malfunction. The use of this device is forbidden in most hospitals and medical clinics.

If you use any other personal medical device, consult the manufacturer of your device to determine if it is adequately shielded from external RF energy. Your physician may be able to assist you in obtaining this information.

Turn the phone OFF in health care facilities when any regulations posted in these areas instruct you to do so. Hospitals or health care facilities may be using equipment that could be sensitive to external RF energy.

## **HEARING AIDS**

Some digital wireless phones may interfere with some hearing aids. In the event of such interference, you may want to consult your service provider, or call the customer service line to discuss alternatives.

## **NONIONIZING RADIATION**

This product should be operated in the suggested normal condition only to ensure the radiative performance and safety of the interference. As with other mobile radio transmitting equipment, users are advised that for satisfactory operation of the equipment and for the safety of personnel, it is recommended that no part of the human body be allowed to come too close to the antenna during operation of the equipment.

## General Precautions

- **Heed service markings**

Except as explained elsewhere in the Operating or Service documentation, do not service any product yourself. Service needed on components inside these compartments should be done by an authorized service technician or provider.

- **Damage requiring service**

Unplug the product from the electrical outlet and refer servicing to an authorized service technician or provider under the following conditions:

- Liquid has been spilled or an object has fallen into the product.
- The product has been exposed to rain or water.

The LDI (Liquid Damage Indicator) is a circular label that changes color when the phone's sensitive area (e.g. battery contacts) is exposed to water.

The color of the LDI changes from white to red when the phone's sensitive area is exposed to water.

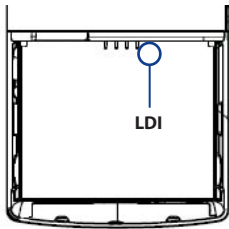

- The product has been dropped or damaged.
- There are noticeable signs of overheating.
- The product does not operate normally when you follow the operating instructions.
- **Avoid hot areas**  
The product should be placed away from heat sources such as radiators, heat registers, stoves, or other products (including, but limited to, amplifiers) that produce heat.
- **Avoid wet areas**  
Never use the product in a wet location.
- **Avoid using your device after a dramatic change in temperature**  
When you move your device between environments with very different temperature and/or humidity ranges, condensation may form on or within the device. To avoid damaging the device, allow sufficient time for the moisture to evaporate before using the device.



**NOTE:** When taking the device from low-temperature conditions into a warmer environment or from high-temperature conditions into a cooler environment, allow the device to acclimate to room temperature before turning on the power.

- **Avoid pushing objects into product**  
Never push objects of any kind into cabinet slots or other openings in the product. Slots and openings are provided for ventilation. These openings must not be blocked or covered.
- **Mounting Accessories**  
Do not use the product on an unstable table, cart, stand, tripod, or bracket. Any mounting of the product should follow the manufacturer's instructions, and should use a mounting accessory recommended by the manufacturer.
- **Avoid unstable mounting**  
Do not place the product with an unstable base.
- **Use product with approved equipment**  
This product should be used only with personal computers and options identified as suitable for use with your equipment.
- **Adjust the volume**  
Turn down the volume before using headphones or other audio devices.
- **Cleaning**  
Unplug the product from the wall outlet before cleaning. Do not use liquid cleaners or aerosol cleaners. Use a damp cloth for cleaning, but NEVER use water to clean the LCD screen.

# Contents

<b>Welcome to T-Mobile</b>	<b>17</b>
Introduction .....	18
T-Mobile Services and Applications .....	19
Voice/Phone.....	19
Voicemail.....	20
E-mail.....	20
Messaging services .....	20
T-Mobile® myFaves <sup>SM</sup> .....	21
T-Mobile HotSpot.....	21
T-Mobile Address Book .....	22
International Service.....	22
Activating Service .....	23
 <b>Chapter 1 Getting Started</b>	 <b>25</b>
1.1 Getting to Know your Phone and Its Accessories .....	26
1.2 Inserting the SIM Card.....	32
1.3 Installing a microSD Card .....	34
1.4 Charging the Battery.....	34
1.5 Turning On the Phone .....	35
1.6 The Home Screen.....	35
Shortcuts Bar .....	36
1.7 Programs On Your Phone .....	39
1.8 Using the Start Menu.....	43
1.9 Using the Quick List .....	44
1.10 Entering Information .....	44
Input modes .....	44
The 20-key QWERTY keyboard.....	45
Multipress mode .....	46
XT9 mode .....	46

Numeric mode .....	47
1.11 Battery Information.....	47
1.12 Shortcut Key .....	48
1.13 Status Indicators.....	49

## **Chapter 2 Using Phone Features 51**

2.1 Using the Phone .....	52
The Phone screen.....	52
Set ring tones .....	52
2.2 Making a Call.....	53
Make a call from the Home screen .....	53
Make a call from Contacts.....	53
Make a call from Call History.....	54
Make a call from Speed Dial .....	55
Make a call from SIM Manager .....	55
2.3 Receiving a Voice Call .....	55
2.4 In-Call Options.....	56
2.5 Additional Dialing Information .....	58
Make an emergency call.....	58
Make an international call .....	58
Insert a pause or long pause in a dialing sequence .....	58

## **Chapter 3 Synchronizing Information with Your Computer 59**

3.1 About Synchronization .....	60
Ways to synchronize .....	60
3.2 Setting Up Windows Mobile® Device Center on Windows Vista .	61
Set up synchronization in Windows Mobile Device Center	61
3.3 Setting Up ActiveSync® on Windows XP .....	62
Install ActiveSync .....	62
Set up synchronization in ActiveSync .....	62
3.4 Synchronizing With Your Computer .....	63
Start and stop synchronization.....	63

Change which information is synchronized .....	64
Troubleshoot sync connection problems .....	64
3.5 Synchronizing via Bluetooth.....	65
3.6 Synchronizing Music and Video.....	66
<b>Chapter 4 Managing your Phone</b>	<b>67</b>
4.1 Personalizing Your Phone.....	68
Set up the Home screen .....	68
Set date, time, language, and other regional options .....	68
Choose how to be notified about events or actions.....	69
Set personal information .....	71
Set performance and maintenance options .....	71
4.2 Adding and Removing Programs .....	72
4.3 Using Task Manager and Managing Memory .....	73
4.4 Managing and Backing Up Files .....	74
Copy files using Windows Mobile Device Center/ ActiveSync to the PC.....	74
Use File Explorer .....	74
4.5 Protecting Your Phone .....	76
4.6 Restarting Your Phone.....	78
4.7 Resetting Your Phone .....	78
4.8 Windows Update .....	79
<b>Chapter 5 Organizing Phone Information</b>	<b>81</b>
5.1 Contacts .....	82
Create a contact on your phone.....	82
Edit and call a contact .....	82
Find a contact.....	83
Share contact information.....	84
5.2 SIM Manager.....	85
5.3 T-Mobile® myFaves <sup>SM</sup> .....	86
T-Mobile myFaves <sup>SM</sup> on the Home screen .....	87

	Add myFaves contacts .....	87
	Call a myFaves contact .....	88
	Edit a myFaves contact .....	89
5.4	Calendar .....	90
	Create a personal appointment.....	90
	View your appointments.....	90
	Send appointments .....	91
5.5	Tasks.....	92
5.6	T-Mobile Address Book .....	93
5.7	Voice Recorder .....	94
5.8	Voice Notes.....	95

## **Chapter 6 Exchanging Messages 97**

6.1	Messaging.....	98
6.2	Text Messages .....	99
	Compose and send text messages.....	99
	Receive text messages .....	99
6.3	Picture Messages.....	100
	Create and send Picture Messages.....	100
	View, reply to and block Picture Messages.....	101
6.4	Using Instant Messaging .....	102
	AIM® .....	102
	ICQ® .....	103
	Yahoo!® .....	105
6.5	Set Up E-Mail.....	106
6.6	Using E-mail .....	108
	Create and reply to e-mails .....	108
	Filter the Inbox message list .....	108
	View and reply to e-mails.....	109
	Send and download e-mails .....	110
	Customize e-mail settings .....	111
6.7	Using Keyboard Shortcuts .....	113

## **Chapter 7 Working with Company E-mails and Meeting Appointments** **115**

7.1 Synchronizing Your Phone with the Exchange Server.....	116
Set up an Exchange Server connection from your phone	116
Set up an Exchange Server connection from your PC.....	118
Start synchronization .....	121
7.2 Working with Company E-mails.....	122
Automatic synchronization through Direct Push.....	122
Scheduled synchronization.....	123
Instant download through Fetch Mail.....	124
Search for e-mails on the Exchange Server .....	124
Flag your messages .....	125
Out-of-office auto-reply .....	125
View a document linked to an e-mail message .....	126
7.3 Managing Meeting Requests.....	126
7.4 Finding Contacts in the Company Directory.....	128
7.5 E-mail Security.....	129
Encrypt and sign messages.....	130
Set permissions on an e-mail message.....	131

## **Chapter 8 Getting Connected** **133**

8.1 Comm Manager .....	134
8.2 Ways of Connecting to the Internet .....	135
8.3 Wi-Fi .....	135
Connect to T-Mobile HotSpot.....	135
Connect to other wireless networks .....	139
8.4 GPRS/EDGE .....	141
8.5 Dial-up and Others .....	141
8.6 Internet Explorer® Mobile .....	143
Browse the Web.....	143
8.7 Using Your Phone as a Modem (Internet Sharing) .....	145

8.8 Bluetooth .....	147
Bluetooth modes .....	147
Bluetooth partnerships.....	148
Connect a Bluetooth hands-free or stereo headset .....	149
Beam information using Bluetooth.....	151
Print files via Bluetooth.....	152
8.9 Windows Live™ .....	153
Set up Windows Live™ .....	153
The Windows Live™ interface.....	155
8.10 Windows Live Messenger .....	155
Launch the messenger and sign in.....	156
Add Windows Live™ contacts.....	156
Send instant messages .....	157
Personalize the messenger.....	159
8.11 Windows Live™ Search .....	159

## **Chapter 9 Experiencing Multimedia** **161**

9.1 Camera .....	162
Take a photo or capture a video clip.....	162
Capture modes .....	162
Camera mode icons and indicators.....	163
Quick Settings Menu .....	165
Use zooming.....	165
Quick Send .....	166
The Review screen .....	167
Camera Capture and Advanced Settings .....	168
9.2 Pictures & Videos .....	169
Copy pictures, animated GIFs and video clips.....	169
View media files.....	169
Pictures & Videos menu .....	170
Send photos to your Windows Live Space.....	170

9.3 Windows Media® Player Mobile .....	172
About the controls.....	172
About the screens and menus .....	173
About licenses and protected files .....	174
Synchronize video and audio files .....	174
Play media .....	177
Playlists .....	178
Troubleshooting.....	179
9.4 Java Applications.....	179
Install and run MIDlets/MIDlet suite .....	179
Manage MIDlets/MIDlet suite.....	181
<b>Chapter 10 Using Other Applications</b>	<b>183</b>
10.1 Microsoft® Office Mobile .....	184
10.2 Microsoft® Office Word Mobile .....	184
View documents.....	184
Edit and send documents .....	185
10.3 Microsoft® Office Excel® Mobile.....	186
View worksheets .....	186
Edit and send worksheets.....	187
10.4 Microsoft® Office PowerPoint® Mobile.....	190
10.5 Microsoft® Office OneNote® Mobile .....	192
10.6 Adobe® Reader® LE.....	193
10.7 Speed Dial .....	193
10.8 Voice Command .....	195
<b>Appendix</b>	<b>197</b>
A.1 Specifications .....	198
A.2 Regulatory Notices .....	201
<b>Index</b>	<b>205</b>



# Welcome to T-Mobile

**Introduction**

**T-Mobile Services and Applications**

**Activating Service**

## Introduction

This User Manual provides you with detailed instructions on using your T-Mobile Shadow™ and services.

You will also find information from the following sources:

### **Windows Mobile® Web site**

(<http://www.microsoft.com/windowsmobile>)

### **T-Mobile Customer Care**

The T-Mobile Customer Care team offers responsive and knowledgeable customer support 24 hours a day, seven days a week. In addition, you can always access free online help for your device at [support.t-mobile.com](http://support.t-mobile.com), and for your account at [my.t-mobile.com](http://my.t-mobile.com).

- **General Questions**

Our Customer Care team can assist in many things including service activation, billing, GSM/GPRS coverage information, voicemail, and feature addition. Just dial 1-800-937-8997 or 611 on your device.

## T-Mobile Services and Applications

With your new T-Mobile Shadow and T-Mobile's service package, you get the freedom of excellent voice and broadband connectivity in many locations nationwide.

**Important** By using T-Mobile services, you acknowledge that you have read, understood and agreed to be bound by each of the terms and conditions of the Service Agreement.

When you activate service with T-Mobile, the following features and services are available to you:

### Voice/Phone

- Local calling and nationwide long distance calling
- International calling \*
- Caller ID
- Call waiting and call hold \*\*
- Conference calling \*\*
- Call forwarding \*\*

**\* Note** Log on to [www.my.t-mobile.com](http://www.my.t-mobile.com) to set up international calling. See [www.tmobile.com/international/](http://www.tmobile.com/international/) for rate and other information on international services.

**\*\* Notes**

- Airtime rates apply for all completed calls. Calls that are forwarded to numbers outside the local calling area are charged long distance rates. These features may include charges for multiple calls.
- Calls made in any T-Mobile coverage area, including 911 calls, may not always be completed due to factors such as weather conditions, terrain, foliage, building structures, and equipment limitations.
- You can use your device to access 911 Emergency Service while you are on a call. You can access 911 even if you DO NOT have a SIM card in the device. All 911 calls are FREE.

## **Voicemail**

Your T-Mobile Shadow has been programmed to forward calls when your line is busy or when you are not available. T-Mobile's voicemail system offers your caller the option to record a voice message that you can play back at your convenience or to send a numeric page to your device.

**Note** Airtime charges apply to receipt and retrieval of voicemail messages.

## **E-mail**

Set Up E-mail (  ) provides you unlimited access to your work and personal email. Instantly access your e-mail from AOL®, Yahoo!®, EarthLink™, Comcast®, Microsoft® Exchange and many more, including any POP3 or IMAP4 e-mail server.

For more information about setting up and using e-mail, see Chapter 6 and 7.

## **Messaging services**

### **Text Messaging (SMS)**

Text messaging allows you to send, receive, and reply to short text messages using your device. Messages may be sent to and from mobile devices that support text messaging. You may be charged for using text messaging depending on your rate plan. Visit [www.t-mobile.com](http://www.t-mobile.com) or a T-Mobile store for domestic and international text messaging rates.

For more information about sending text messages, see Chapter 6.

### **Multimedia Messaging (MMS)**

Picture Messaging allows you to send and receive picture messages. You can take pictures and videos using the device's integrated camera and send them to family and friends. You may be charged for using Picture Messaging depending on your rate plan. Visit [www.t-mobile.com](http://www.t-mobile.com) or a T-Mobile store for domestic and international Picture Messaging rates and information on phones and participating services capable of receiving Picture Messages.

For more information about sending Picture Messages, see Chapter 6.

## Instant Messaging (IM)

Your device comes with instant messaging (IM) applications pre-installed for your convenience. Your normal screen name and password work just as they would on any computer connected to the Internet. You may be charged for using instant messaging depending on your rate plan.

Visit [www.t-mobile.com](http://www.t-mobile.com) or a T-Mobile store for domestic and international instant messaging rates.

For more information about using Instant Messaging, see Chapter 6.

## T-Mobile® myFaves<sup>SM</sup>

T-Mobile® myFaves<sup>SM</sup> helps you stay connected to the people who matter most in your life. Simply choose any five U.S. phone numbers\* you call most often, on any network, and have them displayed on your phone's main screen. To subscribe, go to [www.t-mobile.com](http://www.t-mobile.com).

When you subscribe to the service, you can take advantage of the following:

- Unlimited nationwide calling to any five numbers, on any network (even landlines)
- One-touch calling, text messaging\*\*, and photo sharing\*\*
- No domestic roaming or domestic long-distance charges
- Personalize contacts with favorite pictures\*\* or downloadable icons\*\*

\* Excluding 411, voicemail, toll-free, 900, calling card, customers' own numbers, numbers accessing 500 or more lines - other restrictions may apply.

\*\* Separate purchase/download charges may apply. Separate charges apply to send/receive domestic/international text and picture messages.

For more information, see "T-Mobile® myFaves<sup>SM</sup>" in Chapter 5. You can also visit [www.t-mobile.com](http://www.t-mobile.com) for the latest information.

## T-Mobile HotSpot

T-Mobile HotSpot gives you wireless access to the Internet over the T-Mobile Wi-Fi network in locations across the U.S., such as airports, coffeehouses, bookstores, universities, and more. To access T-Mobile HotSpot, you must add a data plan to your account. Inform your T-Mobile Activations representative that you want to add a data plan when activating service with T-Mobile. Visit [www.t-mobile.com](http://www.t-mobile.com) or a T-Mobile store for plan information.

For more information about T-Mobile HotSpot, see “Connect to T-Mobile HotSpot” in Chapter 8.

## T-Mobile Address Book

This is a free service that allows you to view, back up, and manage your contact, tasks, and calendar items on t-mobile.com. See Chapter 5 for details.

## International Service

You can access the Internet and make calls using your device while abroad. To take advantage of this service, visit [www.my.t-mobile.com](http://www.my.t-mobile.com) or contact Customer Care at **1-800-937-8997** to activate international calling features. Inform the representative that you want to use T-Mobile service (voice and data) internationally. The representative will add the service to your account at no charge. For more information on international service, visit [www.t-mobile.com/international/](http://www.t-mobile.com/international/).

**Note** Additional fees may apply. Countries that support international wireless Internet roaming may not be the same as countries that support international voice roaming.

Please refer to [www.t-mobile.com/international/](http://www.t-mobile.com/international/) for information on world-class Internet service.

## Activating Service

If your service has not been activated, then follow the steps in this section to activate. The T-Mobile Activations representative will set up your service and assign your mobile number. It takes about 20 minutes to activate voice service and may take up to 24 hours to activate data service. Business and government accounts may take additional time to activate voice and data service. By activating service, you acknowledge that you have read and agreed to the Terms and Conditions of the Service Agreement.

1. Have your service agreement and the following information ready for your Activations representative:
  - Name, home address, home phone, preferred billing address.  
**Note** For business and government accounts, your Activations representative will also require your physical address, company name or government agency name, and the tax ID.
  - Social Security number, current driver's license number, and date of birth for credit-check purposes
  - Model number of your device (T-Mobile Shadow)
  - SIM serial number (on the back of the SIM card)
  - IMEI number (on the label under the battery)
  - Agent code (on your service agreement)
  - Your choice of T-Mobile rate plans and services
2. Call Customer Care at 1-800-937-8997 from a landline phone.





# Chapter 1

## Getting Started

### 1.1 Getting to Know your Phone and Its Accessories

#### 1.2 Inserting the SIM Card

#### 1.3 Installing a microSD Card

#### 1.4 Charging the Battery

#### 1.5 Turning On the Phone

#### 1.6 The Home Screen

#### 1.7 Programs On Your Phone

#### 1.8 Using the Start Menu

#### 1.9 Using the Quick List

#### 1.10 Entering Information

#### 1.11 Battery Information

#### 1.12 Shortcut Key

#### 1.13 Status Indicators

## 1.1 Getting to Know your Phone and Its Accessories

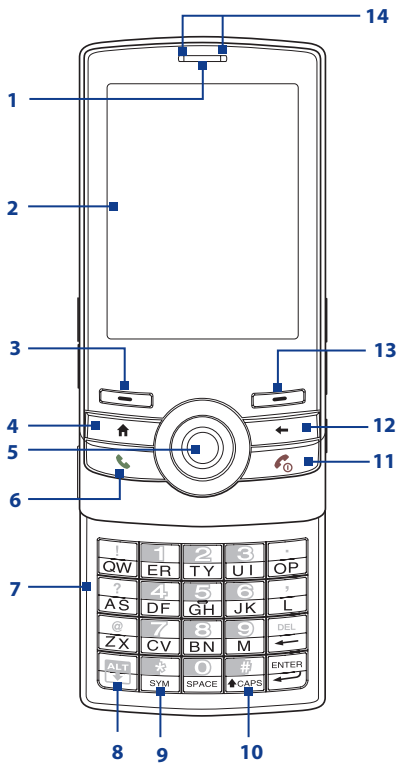

Item	Function
<b>1. Speaker</b>	Listen to a phone call.
<b>2. Display Screen</b>	
<b>3. Left SOFT KEY</b>	Press to perform the command shown in the label above the button.
<b>4. HOME</b>	Press to go to the Home Screen.
<b>5. NAVIGATION WHEEL/CENTER SELECT Key</b>	Use to scroll left, right, up, or down. You can either turn the wheel or press the wheel to scroll through items or screens. Press the center to use as the <b>CENTER SELECT</b> Key.
<b>6. SEND</b>	Press to dial a phone number, answer a call, switch to another call, or put a call on hold. Press and hold to activate/deactivate speakerphone mode.
<b>7. 20-key QWERTY Keyboard</b>	Slide up the front panel of the phone to reveal the keyboard. Use to dial phone numbers, enter information, and write messages.
<b>8. Alt Key</b>	Press once to let you type symbols and enter numbers in text fields. Press twice for continuous symbol or number entries.
<b>9. Symbol Key</b>	Press to open the Symbol pad.
<b>10. Caps Key</b>	Press to type a single capital letter; press twice to type in all caps.
<b>11. END</b>	Press to end a call, or press and hold for about 3 seconds to turn on or off the phone.
<b>12. BACK</b>	Press to go to the previous screen, or backspace over characters.
<b>13. Right SOFT KEY</b>	Press to perform the command shown in the label above the button.
<b>14. LED Indicators</b>	The left LED indicators (green/red/amber) notify you of the battery and network status of your phone respectively, while the right indicators (blue/green) notify you of Bluetooth and Wi-Fi connectivity status. For more information, see "LED indicator lights" in this chapter.

## 28 Getting Started

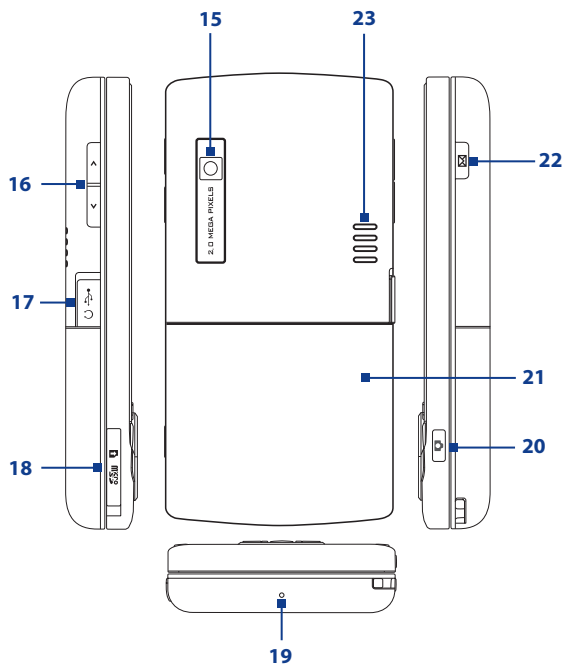

Item	Function
<b>15. Camera Lens</b>	
<b>16. VOLUME CONTROL</b>	Adjust the volume of your phone. Press the Up-arrow button to increase the volume; press the Down-arrow button to decrease the volume.
<b>17. Sync Connector/ Earphone Jack</b>	Use for synchronizing data or recharging the battery. Remove the cover to connect the earphone to listen to audio media or use the phone's hands-free kit.
<b>18. microSD card slot</b>	Remove the cover to insert a microSD™ card.
<b>19. Microphone</b>	Speak into the microphone when receiving or making a phone call or during voice recording.
<b>20. CAMERA</b>	Press to open the Camera program.
<b>21. Back Cover</b>	Remove to insert the battery and SIM card.
<b>22. SHORTCUT KEY</b>	Press or press and hold to open phone applications. By default, briefly pressing this button calls up the Messaging screen; pressing and holding this button activates Voice Command. See "Shortcut Key" in this chapter for more details.
<b>23. Speakers</b>	Listen to audio media or a phone call when using speakerphone mode.

---

## LED indicator lights

Various colors that might display in the two LED Indicators are summarized here.

Left LED	Status
<b>Solid green</b>	Battery is fully charged.
<b>Blank</b>	Battery case is empty, no SIM card inserted or phone is off.
<b>Solid amber</b>	Battery is charging or the phone is using ActiveSync to synchronize with a PC.
<b>Solid red</b>	Battery is not installed or battery is over-discharged.
<b>Flashing green</b>	Connected to the network.
<b>Flashing red</b>	Battery very low (less than 10%).
<b>Flashing amber</b>	Battery temperature is hotter or colder than the functional limits of 32 to 118 degrees Fahrenheit, and has stopped charging.
<b>Amber/Green LED off</b>	Battery fault. The “Battery Fault” indicator (🔋❌) is displayed. In this case, the flashing green LED can be recovered by unplugging the AC adapter.

Right LED	Status
<b>Flashing blue</b>	Bluetooth mode set to “On” or “Visible” mode.
<b>Flashing green</b>	Connected to Wi-Fi network.

## Accessories

The following accessories are provided with the T-Mobile Shadow:

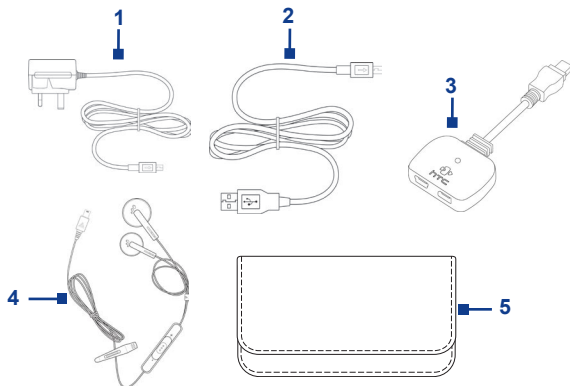

Accessory	Function
<b>1. AC adapter</b>	Recharges the phone battery.
<b>2. USB cable</b>	Connects your phone to a PC to synchronize data and/or to charge the phone.
<b>3. Audio / Charging cable</b>	Allows the use of a travel charger / AC adapter while you're using a stereo headset with your phone.
<b>4. Stereo headset</b>	Provides a volume control slider and a Send/End button. You can press the button to pick up a call or put a call on hold or press and hold the button to end the call. Plug into the Earphone Jack to listen to audio files.
<b>5. Pouch</b>	Acts as a protective carrying case for your phone.

## 1.2 Inserting the SIM Card

Your SIM (Subscriber Identity Module) card is given to you by T-Mobile and contains your basic subscriber information, such as your phone number and your address book.

Before you begin, ensure that the phone is turned off.

### Open the cover and remove the battery

1. Hold the phone in one hand facing down in the palm of your hand, and then with your thumb, press the top of the phone.
2. With your other hand, press the back cover downwards and slide it open.
3. Remove the battery by lifting it up from the bottom end.

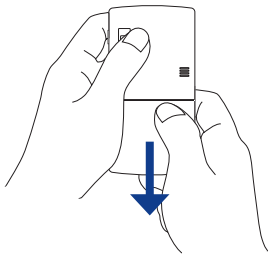

### Insert the SIM card

Insert the SIM card into the slot at the top-left corner (underneath the steel latch) with its gold-plated contacts facing down. Push the SIM card all the way in until the SIM card locks into place.



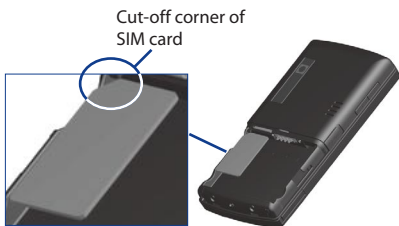

### Remove the SIM card

1. Pull down the steel latch (the SIM card will slide down along with steel latch).
2. Push up the steel latch and then slide out the SIM card.



### Replace the battery

1. Align the exposed metal contacts on the edge of the battery with the prongs in the body of the phone then gently push the top of the battery into place.
2. Press the bottom part of the battery into place.



## 1.3 Installing a microSD Card

You can install a microSD™ (Secure Digital) card on your phone to have an alternative storage place for your images, video, music, and other phone data.

**Note** microSD card is not shipped with the phone.

### To install the microSD card

1. Remove the cover on the right side of the phone.
2. Insert the microSD card into the slot with its gold contacts facing up.

To remove, press the microSD card to pop it out of the slot.



## 1.4 Charging the Battery

You can charge the battery by using either the AC adapter or the USB cable that came in the box.

**Note** You should only use the AC adapter and USB cable that came in the box to charge the battery of the phone.

### Use the AC adapter

1. Plug the AC adapter plug to an electrical outlet.
2. Insert the USB end of the AC adapter to the sync connector port at the side of the phone. The battery is fully charged after about 3 hours.

### Use the USB cable

1. Insert the big USB plug end to a USB port on your computer.
2. Insert the small USB plug end to the sync connector port at the side of the phone.

## 1.5 Turning On the Phone

Turn on the phone by pressing the  button for about 3 seconds.

## 1.6 The Home Screen

The Home screen displays important information, such as upcoming appointments, status indicators, current date and time, battery level, and profile.

The Home screen also gives you quick access to various applications and settings that you frequently use on your phone. Press **NAVIGATION** up/down to go through the icons on the Shortcuts Bar (left panel) of the screen. When an icon is selected, you can then scroll the **NAVIGATION WHEEL** clockwise/counterclockwise or press **NAVIGATION** left/right to go through the available items of that particular Shortcuts Bar icon. Open the item or application by pressing **CENTER SELECT**.

**Tip** To access the Home screen from anywhere, press the **HOME** key on the phone.



Home Screen

1. Select to display all program icons.
2. Shortcuts Bar. See "Shortcuts Bar" in this chapter for details.
3. Displays T-Mobile and the time.
4. Displays notifications, such as missed calls or new messages.
5. Displays the network or connectivity status.
6. Displays the T-Mobile HotSpot status. See Chapter 8 for details.
7. Displays the power status.
8. Displays the network signal strength.
9. Depending on the Shortcuts Bar icon selected, this displays the wallpaper image, an image of an item associated with the Shortcuts Bar icon, T-Mobile® myFaves<sup>SM</sup> contacts, or photos in your phone.
10. Depending on the Shortcuts Bar icon selected, this displays the myFaves contact name, names of the item associated with the Shortcuts Bar icon, messages, notifications, appointments, or music track name.
11. Select to open the program, setting, or shortcut associated with the selected Shortcuts Bar item.

### Shortcuts Bar

The Shortcuts Bar lets you quickly access various information and applications on your phone.

#### myFaves<sup>SM</sup>

Access your myFaves<sup>SM</sup> contacts right on the Home screen. See Chapter 5 for details.

If you do not subscribe to the myFaves service, a different screen is used.

Pressing the **HOME** key while on the Home screen will go to this screen.



with myFaves

without myFaves

## Notifications

Gives you quick access to view missed calls and new messages. This icon gleams when there is a new notification.

Scroll the **NAVIGATION WHEEL** clockwise or counterclockwise to go through the items and then press **CENTER SELECT** to open the notification.



## Message Center

Gives you quick access to your text message and Picture Message inbox. You can also open Voice Notes and create a new e-mail account here.

To quickly create a new text message, Picture Message, or Voice Note, scroll to the item and select **Compose**.

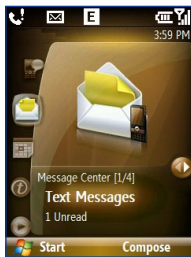

## Appointments

Lets you see your upcoming appointments for the day or set a new appointment. If you have more than one appointment for the day, use the **NAVIGATION WHEEL** to scroll through the appointments.

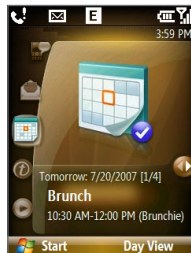

## Internet

Quickly open your browser to surf the Internet or access t-zone to purchase ring tones and wallpapers. You can also access your T-Mobile account here.

You can quickly go to the t-zone page to purchase wallpapers or ringtones by selecting **Browse Wallpaper** or **Browse Hi-Fi Ringers**.



## Media

A music player right on the Home screen. Use the **NAVIGATION WHEEL** to scroll through the music in your phone and then press **CENTER SELECT** to play back and pause music.

While playing back a song, select **Full Screen** to open Windows Media Player to display more playback controls.



## Photos

Browse through the photos in your phone by using the **NAVIGATION WHEEL**. Press **CENTER SELECT** to view the photo.

While viewing the photo, you can quickly send the image you are viewing via Picture Message or send it to your Live Space account.

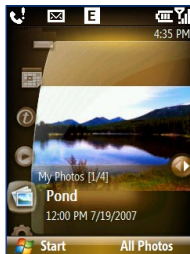

## Settings









Lets you quickly access the Comm Manager and Task Manager, change your profile, wallpaper, or ring tone, and check the phone's battery power.











Select **All Settings** to show the Settings screen.



## 1.7 Programs On Your Phone











The following table lists icons of the programs that are already installed on your phone or are available on the discs that came with your phone.



Icon	Program	Description
	<b>Accessories</b>	 <b>Calculator</b> Do basic arithmetic and calculations.
		 <b>Clear Storage</b> Clear the memory and restore the phone back to factory default settings.
		 <b>Internet Sharing</b> Turn your phone to an external modem for your computer.
		 <b>SIM Manager</b> Manage the contacts that are stored on your SIM card.
		 <b>Voice Recorder</b> Create short voice recordings.
		 <b>MMS Settings</b> Lets you set Picture Message preferences and settings.
	<b>ActiveSync</b>	Synchronizes information between your phone and PC.

Icon	Program	Description
	<b>Applications</b>	 <b>Adobe Reader LE</b> View PDF files.
		 <b>Camera</b> Capture photos in various modes.
		 <b>Java Applications</b> Download and install Java-based applications, such as games and tools, on your phone.
		 <b>Video Recorder</b> Capture video clips in various modes and duration.
	<b>Calendar</b>	Keep track of your appointments, and create meeting requests.
	<b>Call History</b>	Keep track of all phone calls made, received, and missed.
	<b>Comm Manager</b>	Manage your phone's connections (including Wi-Fi, GPRS/EDGE, Bluetooth, and ActiveSync), turn the phone on or off, enable or disable the Direct Push function, and more.
	<b>Contacts</b>	Keep track of contact information.
	<b>File Explorer</b>	Organize and manage files and folders.
	<b>Games</b>	Play two games, Bubble Breaker and Solitaire, that come with your phone.
	<b>Handango InHand</b>	Browse, purchase, and install applications for your phone.
	<b>Internet Explorer</b>	Browse Web and WAP sites as well as download new programs and files from the Internet.
	<b>Instant Messaging</b>	Access various instant messaging programs such as AOL®, ICQ® and Yahoo®.
	<b>Live Search</b>	Search for locations that suit your interests, plan a driving route, check map, and see traffic conditions.



Icon	Program	Description
	<b>Office Mobile</b>	Use the complete suite of Microsoft® Office applications for your phone. <ul style="list-style-type: none"> <li> <b>OneNote Mobile</b> Create OneNote files on your phone and then synchronize them with your PC.</li> <li> <b>Excel Mobile</b> View and edit Microsoft® Excel® worksheets.</li> <li> <b>PowerPoint Mobile</b> View Microsoft® Powerpoint® presentation files.</li> <li> <b>Word Mobile</b> View and edit Microsoft® Word documents and text files.</li> </ul>
	<b>Messaging</b>	Send and receive e-mails, text messages, and picture messages.
	<b>Messenger</b>	Use this mobile version of Windows Live Messenger.
	<b>myFaves</b>	Use T-Mobile® myFaves <sup>SM</sup> to stay connected to the people who matter most in your life. Simply choose any five U.S. phone numbers you call most often, on any network, and have them displayed on your phone's Home screen.
	<b>Pictures &amp; Videos</b>	View and manage pictures, animated GIFs, and video files on your phone or a storage card.
	<b>Settings</b>	Personalize your phone to suit the way you use it.
	<b>Set Up E-Mail</b>	Enjoy unlimited access to your work and personal email. Instantly access your e-mail from AOL®, Yahoo!®, EarthLink™, Comcast®, Microsoft® Exchange and many more, including any POP3 or IMAP4 e-mail server.
	<b>Speed Dial</b>	Create speed dial entries for dialing frequently-called phone numbers or for opening frequently-accessed programs.

Icon	Program	Description
	<b>T-Mobile Address Book</b>	Synchronize and back up contacts, tasks and calendar items on your phone with the T-Mobile Web site.
	<b>T-Mobile HotSpot</b>	<p> <b>HotSpot Settings</b> Enter your HotSpot username and password to automatically connect when you are in a T-Mobile HotSpot. You need to have a T-Mobile HotSpot account to access the T-Mobile HotSpot wireless network.</p> <p> <b>HotSpot Status</b> See if you are in the T-Mobile HotSpot coverage area. Use this program to log off from T-Mobile HotSpot.</p>
	<b>t-zones</b>	<p>Open a WAP browser and visit T-Mobile's t-zones Web site to purchase ring tones, wallpaper, or games to personalize your phone. You can also manage your accounts and access other helpful information.</p> <p>You can quickly go to the t-zone page to purchase wallpapers or ringtones by scrolling down to  on the Shortcuts bar and selecting <b>Browse Wallpaper</b> or <b>Browse Hi-Fi Ringers</b>.</p>
	<b>Task Manager</b>	Close running programs on your phone.
	<b>Tasks</b>	Keep track of your tasks.
	<b>Voice Command</b>	Call contacts, open applications, play back music, and get calendar information just by using your voice.
	<b>Voice Notes</b>	Record a voice clip and quickly send it over MMS.

Icon	Program	Description
	<b>Windows Live</b>	Use this mobile version of Windows Live™ to find information on the Web. It also lets you sign into your Windows Live account so that you can access your Live Mail messages and send/receive instant messages in Live Messenger.
	<b>Windows Media Player</b>	Play back video and audio files.

## 1.8 Using the Start Menu

The Start menu is located at the bottom-left corner of the Home screen and displays various program icons that are spread across one or more screens.

### To see the available programs in the Start menu

On the Home screen, select **Start**. To see more programs, select **More** or use the **NAVIGATION WHEEL**.

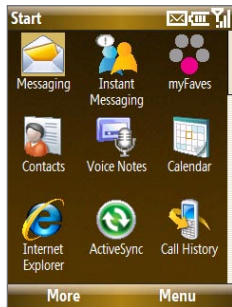

Start menu

## 1.9 Using the Quick List

The Quick List offers convenient access to a list of functions, such as locking your phone, opening Comm Manager, and choosing a different profile. For more information about profiles, see Chapter 4.

### To access the Quick List

1. Press and hold the **HOME** button.
2. Scroll through the list and select the desired option. Then, do any of the following:
  - Select **Select**.
  - Press the corresponding number on the 20-key QWERTY keyboard.
  - Press **CENTER SELECT**.
3. To exit the Quick List at any time, select **Cancel**.

## 1.10 Entering Information

You can enter text, numbers, and symbols by using the 20-key QWERTY keyboard. When you select a field that requires entering text or numbers, the phone automatically selects the appropriate input mode. The status indicator on the top-right side of the display screen shows the input mode that you are currently using.

### Input modes

<b>abc</b>	Lowercase text input	<b>12#</b>	Numeric or symbol (labeled in blue color) input, locked
<b>ABC</b>	Uppercase text input, caps lock	<b>xT9</b>	XT9 text input mode, lowercase
<b>ABC</b>	Uppercase text input	<b>xT9</b>	XT9 text input mode, uppercase
<b>12#</b>	Numeric or symbol (labeled in brown color) input	<b>xT9</b>	XT9 text input mode, caps lock







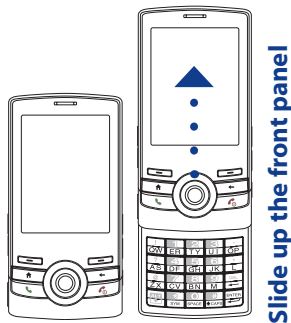

To change the input method, press and hold  and select the input method you want to use on the menu.

## The 20-key QWERTY keyboard

To reveal the 20-key QWERTY keyboard, slide up the front panel of the phone.



You can do the following with the 20-key QWERTY keyboard:

- To use all uppercase letters, press  twice. To change back to all lowercase letters, press  again.
- To use a single uppercase letter, press  and then press the corresponding key.
- To enter a number or symbol (labeled in brown color), press  and then press the corresponding key.
- Press  to open the Symbol pad. Press and hold  to open the input menu.
- While on the Home screen, press and hold  to lock the phone.
- While on the Home screen, press and hold  to toggle between Ringer and Vibrate modes.
- Press and hold  to access your voicemail. Your voicemail number must be set up for this to work. To check, select **Start > Settings > Phone > Call Options** and then check **Voice mail number**.

## Multipress mode

In Multipress mode, you enter a character by pressing the key on which the character appears.

### To enter text in Multipress mode

- To enter the first character on the numeric key, press once. To enter the second character on the numeric key, press twice, and so on.
- To enter character that are on the same key, wait for the line under the character to disappear before you press the key again.

### To change the Multipress time out

You can change the length of time to pause between keypresses on the same numeric key.

1. On the Home screen, select **Start > Settings > More > Accessibility**.
2. In **Multipress time out**, choose the length of the pause between keypresses and select **Done**.

## XT9 mode

To form a word in XT9 mode, press the keys that contain the letters you want. As you enter letters, XT9 analyzes your keypresses and attempts to complete the word. XT9 also tries to predict your next word based on previous sentences you have type.

### To enter text in XT9 mode

1. Press and hold the  key.
2. On the menu, select **XT9 English**.

To change XT9 settings, press and hold  and on the menu, choose **XT9 Settings**.



**Tip** To type in all uppercase letters, press the  key twice.

While typing, words will appear at the bottom of the screen. Use the **NAVIGATION WHEEL** to choose the word you want to insert and press **CENTER SELECT**.

## Numeric mode

If a text box permits a numeric entry only, such as a phone number, the input mode automatically defaults to Numeric mode. However, if you need to enter numbers within a line of text, change to Numeric mode (**123** on the menu), and then change back to Multipress or XT9 mode to finish entering the text.

### To enter numbers in text boxes

1. Press and hold the  key and select **123** on the menu.
2. On the keyboard, enter the number(s) you want.
3. Change back to Multipress or XT9, by pressing and holding the  key and selecting the input mode, and then finish entering your text.

## 1.11 Battery Information

Battery performance depends on many factors, including T-Mobile's network configuration, signal strength, the temperature of the environment in which you operate your phone, the features and/or settings you select and use, items attached to your phone's connecting ports, and your voice, data, and other program usage patterns.

Battery life estimates (approximations):

- Talk time: Up to **7** hours
- Standby time: Up to **175** hours
- Playing WMV: Up to **8** hours
- Playing WMA: Up to **12** hours

**WARNING!** To reduce risk of fire or burns:

- Do not attempt to open, disassemble, or service the battery pack.
- Do not crush, puncture, short external contacts, or dispose of in fire or water.
- Do not expose to temperatures above 140°F.
- Replace only with the battery pack designated for this product.
- Recycle or dispose of used battery as stipulated by local regulation.

### To check and optimize battery power

On the Home screen, scroll down to  on the Shortcuts Bar, then select **Manage Battery**. On the **Power Management** screen, adjust the backlight, display, and light sensor settings.

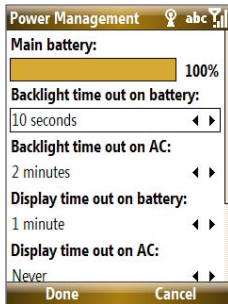

### To manage low battery

When the low-battery warning appears, do the following:

1. Immediately save your current data.
2. Synchronize with your PC or use the AC adapter to charge the battery.
3. Turn off your phone. Turn it back on only when you need to use it.

## 1.12 Shortcut Key

The **SHORTCUT KEY** on the right side of the phone can be configured to open 2 applications that you set. By default, briefly pressing the **SHORTCUT KEY** calls up a message screen (afterwards, it opens the Messaging program); pressing and holding the **SHORTCUT KEY** opens Voice Command.















### To customize Shortcut Key settings





















1. Select **Start > Settings > Shortcut Key**.
2. In **Short press**, select the application to open when you briefly press the **SHORTCUT KEY**.
3. In **Press and hold**, select the application to open when you press and hold the **SHORTCUT KEY**.
4. Select **Done**.



## 1.13 Status Indicators

The following table lists common status indicators and their meanings.

Icon	Description
	T-Mobile HotSpot in use
	T-Mobile HotSpot detected, user is not logged in
	Wi-Fi is on, but phone not connected to a wireless network
	Wi-Fi connected
	Connecting to wireless network
	Synchronizing via Wi-Fi
	Battery level
	Low battery
	Very low battery
	Battery charging
	No battery or battery fault
<b>abc</b>	Lowercase text input
<b>ABC</b>	Uppercase text input, caps lock
<b>ABC</b>	Uppercase text input
<b>12#</b>	Numeric or symbol (labeled in blue color) input, locked
<b>12#</b>	Numeric or symbol input (labeled in blue color)
<b>xt9</b>	XT9 text input mode, lowercase
<b>Xt9</b>	XT9 text input mode, uppercase
<b>Xt9</b>	XT9 text input mode, caps lock
<b>E</b>	EDGE available
	EDGE in use
<b>G</b>	GPRS available
	GPRS connecting
	GPRS in use

Icon	Description
	New e-mail or text message (SMS, Short Message Service)
	New instant message from Live Messenger
	Signal strength
	Radio connected or no signal
	Radio off
	Vibrate call alert
	Ringer off
	Speakerphone on
	Voice call in progress
	Data call in progress
	Calls forwarded
	Call on hold
	Missed call
	Dialing while no SIM card is inserted
	No SIM card installed
	SIM card with fault
	Microphone muted
	Bluetooth
	Bluetooth headset connected
	Sync error

# Chapter 2

## Using Phone Features

**2.1 Using the Phone**

**2.2 Making a Call**

**2.3 Receiving a Voice Call**

**2.4 In-Call Options**

**2.5 Additional Dialing Information**



## 2.1 Using the Phone

You can use your phone to make, receive, and keep track of voice calls, and send text messages (SMS, Short Message Service) and Multimedia Messages (Multimedia Messaging Service). You can also dial a phone number directly from Contacts, and easily copy SIM contacts to Contacts on the phone.

### The Phone screen

From the Phone screen, you can open, call, or find a contact, and even save a new number in Contacts. To access the Phone screen, do any of the following:

- Press .
- Open the keyboard and directly enter the phone number by pressing numeric keys on the keyboard.

### Set ring tones

You can choose how to be notified for incoming calls, reminders, new messages, alarms, and more.

#### To set a ring tone for incoming calls

1. On the Home screen, scroll down to  on the Shortcuts Bar, then select **Change Ringtone**.
2. In the **Ring tone** list, select a ring tone.
3. Select **Done**.

If you select Vibrate, the sound is muted and the phone will vibrate when you receive a call. The Vibrate icon () appears in the title bar. Selecting **None** in the Ring tone list mutes the phone. For more information about sounds, see “Choose how to be notified about events or actions” in Chapter 4.

**Note** To adjust the earpiece volume during a call, use the **VOLUME BUTTONS** on the side of the phone.

## 2.2 Making a Call

With your phone, you can make calls from the Home screen, the Phone screen, from Contacts, Speed Dial, Call History, or SIM Contacts (contacts stored on your SIM card). You can choose to dial by name or number.

### Make a call from the Home screen

- Enter the phone number or name of the contact on the keyboard, and press .
- Press the **BACK** button or **DEL** key if you need to backspace.



Phone Screen

**Tip** You will notice that when you press a key on the keyboard, a list of names and numbers is displayed as your phone searches Contacts, Call History, Speed Dial, and your SIM card to find a matching name or number. For example, when you press a key such as 5, names that begin with **G** and **H** will be displayed as well as phone numbers that start with 5. The next key you press continues to narrow the search. When you see the name of the person you want to call, select it, and press .

### Make a call from Contacts

1. On the Home screen, select **Start > Contacts**.
2. Select the desired contact, and press .

You can also select the desired contact in the contact list, and press **CENTER SELECT** twice (once to view the contact details, and once to dial the associated number).

### To specify the number to dial

1. On the Home screen, select **Start > Contacts**.
2. Select the contact.
3. Press **NAVIGATION** left or right. The letter representing the number changes to m (mobile), w (work), or h (home).

You can also select a contact in the contact list, and press **CENTER SELECT** to view details and different numbers associated with the contact. Select a number and press  or press **CENTER SELECT** to dial the number.

- You may also access the contact list by selecting **Contacts** on the Home Screen.
- To view or edit information associated with the selected contact, select **Menu > Edit**.
- To save a contact on your SIM card, select **Menu > Save to SIM**.

### Make a call from Call History

1. On the Home screen, select **Start > Call History**.
2. Select a name or number, and press .

In the Call History screen, press **CENTER SELECT** to view details, such as the dialed, missed, or received call, call duration, date, and time. Pressing **CENTER SELECT** again dials the associated number.

### To customize calls

You can select various options on the Call History screen to customize and filter the calls made, received, or missed.

- To find a name or number in Contacts, select **Menu > Find Contact**.
- To send a text message, select **Menu > Send Text Message**.
- To send an e-mail, select **Menu > E-mail**.
- To find the duration of a call, select **Menu > View Timers**.
- To remove a call or number from Call History, select **Menu > Delete**.
- To remove the list of calls or numbers from **Call History**, select **Menu > Delete List**.

- To save a name or number in Contacts, select **Menu > Save to Contacts**.
- To categorize the call or number into various call types, select **Menu > Filter**.

**Note** You can also save a number in Contacts by selecting Save on the Call History screen.

## Make a call from Speed Dial

You can make calls using Speed Dial. To learn how to use Speed Dial, see Chapter 10.



## Make a call from SIM Manager

1. Select **Start > Accessories > SIM Manager**. Wait for the contents of your SIM card to load.
2. Choose the contact you want to call and select **Menu > Dial**.

## 2.3 Receiving a Voice Call

When you receive a phone call, you have the option to answer, ignore, or reject it. You can also use the **VOLUME BUTTONS** to lower the ringer volume.

### To answer, ignore or reject an incoming call

- To answer the call, open the keyboard.
- To answer the call, select **Answer**, or press .
- To ignore or reject the call, select **Ignore**, or press .

### To end a call

- If the keyboard is opened, close the keyboard.
- Press .

You can set answering and ending call options by selecting **Start > Settings > Slide and Key Lock**. Choose the options you want in **Answer mode** and **Hang up mode**.

## 2.4 In-Call Options

Your phone provides various options for managing multiple calls at the same time. You are notified when you have another incoming call, and you have the choice of ignoring or accepting the call. If you are already on a call and accept the new call, you can choose to switch between the two callers, or set up a conference call between all three parties.

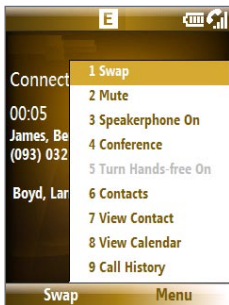

In-Call Options

**Note** Call Waiting should be enabled and supported for you to be notified of an incoming call when you are using the phone. To enable Call Waiting, select **Start > Settings > Phone > Call Waiting > Provide call waiting notifications**.

### To answer another call

1. Select **Answer** to take the second call and put the first call on hold.
2. To end the second call and return to the first call, press .

### To switch between calls

- To switch between two calls, select **Swap**.

### To set up a conference call

1. Either put a call on hold and dial a second number, or, answer a second incoming call during a call.
2. Select **Menu > Conference**.





## Notes

- If the conference connection is successful, the word “Conference” appears at the top of the screen.
- To add additional persons to your conference call, select **Menu** > **Hold**, enter the phone number, and then select **Resume** to return to the call.

## To turn on and off the Speakerphone

The built-in Speakerphone allows you to talk hands-free or lets other people listen to the conversation.

- During a call, select **Menu** > **Speakerphone On**. The  icon appears at the top of the screen.
- To turn off the Speakerphone during the call, select **Menu** > **Speakerphone Off**. Alternatively, the speakerphone can be toggled on and off by pressing and holding  during the call.

**Note** It is not recommended to hold your phone against your ear when the Speakerphone is turned on as this may damage your hearing.

## To mute a call

You can turn off the microphone during a call, so that you can hear the caller but the caller cannot hear you.

Press the left **SOFT KEY** to select **Mute**. When the microphone is turned off, the  icon appears on the screen. Press the left **SOFT KEY** to select **Unmute** to turn on the microphone again.



## 2.5 Additional Dialing Information

### Make an emergency call

Dial the emergency number (911), and press .

**Tip** Additional emergency numbers may be included in your SIM card. Contact your service provider for details.

### Make an international call

1. Press and hold the  key on the keyboard until  appears.

2. Enter the full phone number, and press .

For example: +(1)(909)(22222222) (country code) + (area code) + (phone number).

### Insert a pause or long pause in a dialing sequence

Some international calls or phone numbers require a pause or long pause in the dialing sequence in order for the call to process successfully.

1. On the Home screen, select **Start > Contacts**.
2. Select the contact and press **CENTER SELECT** to open the contact card.
3. Select **Menu > Edit**.
4. Position the cursor on the phone number where you want to insert a pause.
5. Select **Menu > Insert Pause** or **Insert Wait**.  
The letter “p” (Insert Pause) or “w” (Insert Wait) will appear in the number sequence to indicate where the pause or long pause will occur.

**Note** Long pause is not available for contacts stored on the SIM card.

6. Select **Done**.

**Note** When you call a number that contains a long pause, you must press  again to continue dialing.

# Chapter 3

## Synchronizing Information with Your Computer

### 3.1 About Synchronization

### 3.2 Setting Up Windows Mobile® Device Center on Windows Vista

### 3.3 Setting Up ActiveSync® on Windows XP

### 3.4 Synchronizing With Your Computer

### 3.5 Synchronizing via Bluetooth

### 3.6 Synchronizing Music and Video

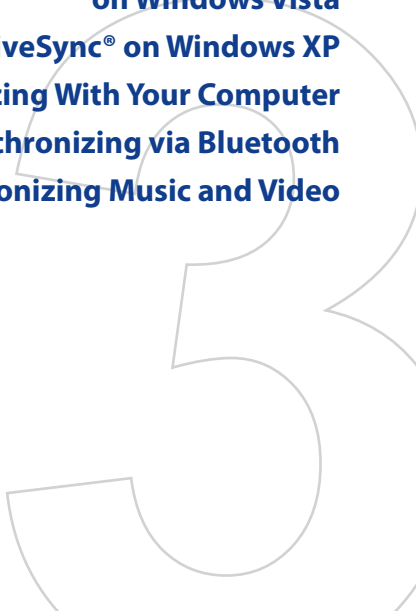

## 3.1 About Synchronization

You can take information from your computer wherever you go by synchronizing them to your phone. The following types of information can be synchronized:

- **Microsoft® Outlook® information**, which include Outlook e-mail, contacts, calendar, tasks, and notes
- **Media**, such as pictures, music and video
- **Favorites**, which are the bookmarked links to your favorite Web sites
- **Files**, such as documents and other files

Before you can synchronize, you need to install first the synchronization software to your computer. For information on installing and using the synchronization software on your computer, see “Setting Up Windows Mobile® Device Center on Windows Vista” and “Setting Up ActiveSync® on Windows XP” in this chapter.

### Ways to synchronize

After you have installed the synchronization software to your computer, synchronize your phone with your computer by using one of the following:

- Connect and synchronize using the supplied USB sync cable. Upon connecting the sync cable to your phone and your computer, the synchronization process starts automatically.
- Connect and synchronize using Bluetooth. You must first set up a Bluetooth partnership between your phone and your computer before you can synchronize information between them using Bluetooth. For more information about setting up a Bluetooth partnership, see Chapter 8. For information about synchronizing through Bluetooth, see “Synchronizing via Bluetooth” later in this chapter.

**Note** You can also synchronize Outlook e-mail, contacts, calendar, and tasks on your phone with the Exchange Server at your work. For more information about setting up your phone to synchronize with the Exchange Server, see Chapter 7.

## 3.2 Setting Up Windows Mobile® Device Center on Windows Vista

Microsoft Windows Mobile® Device Center is the replacement for Microsoft® ActiveSync® on Windows Vista®.

**Note** Some versions of Windows Vista come with Windows Mobile Device Center already installed. If Windows Mobile® Device Center is not available on your Windows Vista, you can install it from the Getting Started Disc that came with your phone.

### Set up synchronization in Windows Mobile Device Center

1. Connect your phone to your PC. Windows Mobile® Device Center configures itself and then opens.
2. On the license agreement screen, click **Accept**.
3. On the Windows Mobile® Device Center's Home screen, click **Set up your device**.

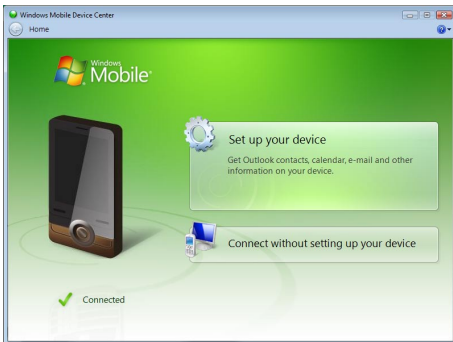

**Note** Choose **Connect without setting up your device** if you only want to transfer media files, check for updates, and explore your phone but not sync Outlook information.

4. Select the items that you want to synchronize then click **Next**.
5. Enter a device name for your phone and click **Set Up**.

When you finish the wizard, Windows Mobile Device Center synchronizes your phone automatically. Notice that Outlook e-mails and other information will appear on your phone after synchronization.

### 3.3 Setting Up ActiveSync® on Windows XP

The Getting Started Disc that comes with your phone contains Microsoft® ActiveSync® 4.5 or later. Follow the steps below to install and set up ActiveSync on Windows XP or other compatible Windows systems.

#### Notes

- You can also download ActiveSync 4.5 from the Microsoft ActiveSync Web site:  
<http://www.microsoft.com/windowsmobile/activesync/activesync45.msp>
- From the above Web site, you will find the system requirements for ActiveSync 4.5.

#### Install ActiveSync

1. Insert the Getting Started Disc into the disc drive on your PC.
2. Click **Setup and Installation**.
3. Select the **ActiveSync** check box and click **Install**.
4. Read the license terms and click **Accept**.
5. When installation is complete, click **Done**.
6. On the Getting Started with Windows Mobile screen, click **Close**.

#### Set up synchronization in ActiveSync

Follow the steps below to set up a synchronization partnership.

1. Connect your phone to your PC. The Synchronization Setup Wizard automatically starts and guides you to create a synchronization relationship. Click **Next** to proceed.
2. To synchronize your phone with your computer, clear the **Synchronize directly with a server running Microsoft Exchange Server** check box then click **Next**.
3. Select the items that you want to synchronize and then click **Next**.

4. Select or clear the **Allow wireless data connections** check box according to your preference.
5. Click **Finish**.

When you finish the wizard, ActiveSync synchronizes your phone automatically. Notice that Outlook e-mails and other information will appear on your phone after synchronization.

## 3.4 Synchronizing With Your Computer

Connect your phone to your PC to synchronize the information between your phone and PC. While your phone is connected, Windows Mobile Device Center or ActiveSync on your PC automatically synchronizes when you make a change on either the PC or your phone.

### Start and stop synchronization



You can also manually start and stop synchronization either from your phone or PC.

#### From your phone



1. After connecting your phone to your PC, select **Start > ActiveSync** on your phone.
2. Select **Sync** to start synchronization.  
To end synchronization before it completes, select **Stop**.

**Note** To delete a partnership with one PC completely, select **Menu > Options**, select the computer name, then select **Menu > Delete**.

#### From Windows Mobile Device Center

1. Click **Start > All Programs > Windows Mobile Device Center**.
2. Click  at the lower left of the Windows Mobile Device Center.  
To end synchronization before it completes, click .

#### From ActiveSync on your PC

- To manually start synchronization, open ActiveSync on your PC and click .
- To end synchronization before it completes, click .

## Change which information is synchronized

You can add or reduce the types of information to synchronize between your phone and PC.

1. Before changing synchronization settings on your phone, disconnect your phone from your PC.
2. On your phone, select **Start > ActiveSync**.
3. Select **Menu > Options**.
4. Select or clear the items you want to synchronize or not synchronize. If you cannot select a check box, you might have to clear the check box for the same information type elsewhere in the list.
5. To customize settings for an item, select that item and select **Settings**. Settings are not available for all items.

### Notes

- The check boxes of the Favorites, Files, Media, and OneNote items are always grayed out in ActiveSync Options on your phone. You can only select or clear these items from Windows Mobile Device Center or ActiveSync on your computer.
- A PC can have sync partnerships with many different Windows Mobile® powered devices, but a device can have sync partnerships with at most two PCs only. To ensure that your phone will synchronize properly with both PCs, set up the second PC using the same synchronization settings you used on the first PC.
- Outlook e-mail can be synchronized with only one computer.

## Troubleshoot sync connection problems

When the PC is connected to the Internet or a local network, in some cases, the PC may disconnect the ActiveSync connection with your phone in favor of the Internet or network connection. If this happens, select **Start > Settings > Connections > More > USB to PC**, then clear the **Enable advanced network functionality** check box. This makes ActiveSync utilize a serial USB connection with your phone.



## 3.5 Synchronizing via Bluetooth

You can connect and synchronize your phone with the PC using Bluetooth.

### To synchronize with a computer via Bluetooth

1. Set up the synchronization software (Windows Mobile Device Center or ActiveSync) on your computer to use a Bluetooth connection. For more information, see the software Help on your computer.
2. On your phone, select **Start > ActiveSync**.
3. Make sure that Bluetooth on both your phone and the computer are turned on and set to **Visible** mode. For more information, see “Bluetooth” in Chapter 8.
4. Select **Menu > Connect via Bluetooth**.
5. If this is the first time you have connected to this computer via Bluetooth, you must first complete the Bluetooth wizard on your phone and set up a Bluetooth partnership between your phone and the computer. For more information about creating a Bluetooth partnership, see “Bluetooth partnerships” in Chapter 8.

### Notes

- To preserve battery power, turn off Bluetooth when not in use.
- To connect and synchronize your phone with a computer via Bluetooth, your computer must have built-in Bluetooth or installed with a Bluetooth adapter or dongle.

## 3.6 Synchronizing Music and Video

If you want to carry your music or other digital media along with you while you travel, set up Microsoft® Windows Media® Player on your computer to synchronize music and video with your phone.

Other than selecting the **Media** information type in ActiveSync to be synchronized, all media synchronization settings must be set in Windows Media® Player. Before media can be synchronized, you must do the following:

- Install Windows Media® Player 11 on the PC. (Windows Media® Player 11 works only in Windows XP or later versions).
- Connect your phone to the PC with a USB cable.
- Set up a sync partnership between the phone and your PC's Windows Media® Player.

**Note** Use Windows Media® Player 11 to properly transfer digitally protected music files from your computer to your phone. If you do not use Windows Media® Player 11 to synchronize the files, you will not be able to play them on your phone.

For more information about using Windows Media® Player on your phone, see “Windows Media® Player Mobile” in Chapter 9.

# Chapter 4

## Managing your Phone

**4.1 Personalizing Your Phone**

**4.2 Adding and Removing Programs**

**4.3 Using Task Manager and Managing Memory**

**4.4 Managing and Backing Up Files**

**4.5 Protecting Your Phone**

**4.6 Restarting Your Phone**

**4.7 Resetting Your Phone**

**4.8 Windows Update**

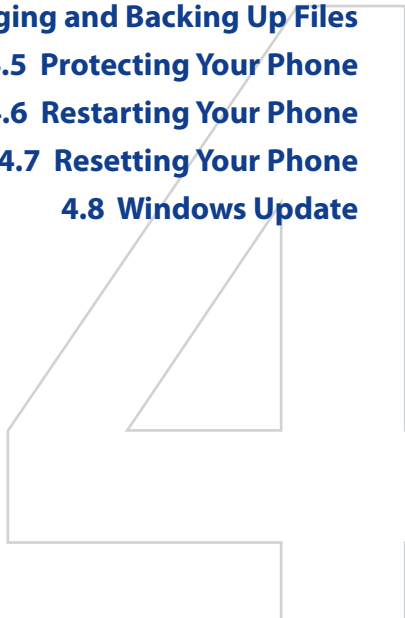

## 4.1 Personalizing Your Phone

### Set up the Home screen

The Home screen is your starting place for most tasks. You can gain access to all features and programs from the Home screen.

#### To customize the Home screen

1. On the Home screen, select **Start > Settings > Home Screen**.
2. In **Home screen layout**, **Color scheme**, **Background image**, and **Time out**, choose the options you want, and select **Done**.

**Tip** If you only want to change the background image, you can do it from the Shortcuts Bar. On the Home screen, scroll down to  on the Shortcuts Bar, then select **Change Wallpaper**.

#### To set a picture as the background

1. On the Home screen, select **Start > Pictures & Videos**.
2. Select the picture you want to set as the background. Select **View** or press **CENTER SELECT** for a larger view of the image.
3. Select **Menu > Use as Home Screen**.
4. Use the **NAVIGATION WHEEL** to select the portion of the picture you want to use, and select **Next**. If the picture fits the screen, this step is skipped.
5. In **Adjust the transparency**, select a higher percentage for a more transparent picture and then select **Finish**.

### Set date, time, language, and other regional options

Your phone should already be set up with the regional settings that are appropriate for your locale.

#### To change regional settings

You can specify the language, locale, date and time style, as well as number and currency formatting options.

1. On the Home screen, select **Start > Settings > More > Regional Settings**.
2. In **Language**, select your preferred language.

3. In **Locale**, select the locale for the language you selected. The Locale option automatically changes the format of the remaining options (such as date, time, and currency) according to the locale you specify.
4. Select **Done**.

#### To set the date and time

1. On the Home screen, select **Start > Settings > Clock & Alarm > Date and Time**.
2. Set the **Time zone**, **Date**, and **Time**, and then select **Done**.

### Choose how to be notified about events or actions

A profile is a group of settings that determine how your phone will alert you to phone events such as incoming calls and notifications.

#### To change the current profile

1. On the Home screen, scroll down to  on the Shortcuts Bar, then select **Change Profile**.
2. Choose a new profile, and select **Done**.

**Tip** To quickly change the profile, press and hold the **HOME** key to display the Quick List, and choose a profile.

#### To edit a profile

1. On the Home screen, scroll down to  on the Shortcuts Bar, then select **Change Profile**.
2. Select the profile to edit.
3. Select **Menu > Edit**.
4. Modify the settings, and select **Done**. To cancel without saving changes, select **Cancel**.

**Tip** To revert to the default profile settings, select **Menu > Reset to default**.

### To specify the sound for an event

1. On the Home screen, scroll down to  on the Shortcuts Bar, then select **Change Ringtone**.
2. For the desired event, select a sound. Select **None** if you do not want to hear a sound.
3. Select **Done**.

**Note** For ring tones, you can use sound files in either the .wav, .mid, .wma, or .mp3 file format. For notifications or reminders, you can use .wav or .mid files.

**Tip** When you select a sound, the sound plays. To hear it again, select **Menu > Play**.

### To copy a sound to your phone

After a sound file is located on your phone, you can use it for a ring tone, notification, or reminder. Sound files in either .wav, .mid, .wma, or .MP3 formats can be used.

1. Connect the phone to your PC using a USB connection.
2. On your PC, copy the sound file you want.
3. In Windows Mobile Device Center, click **File Management > Browse the contents of your device**.  
Or  
In ActiveSync on your PC, click **Explore** and double-click **My Windows Mobile-Based Device**.
4. Save the sound file on your phone by going to **Application Data > Sounds**, and pasting the file into that folder.

### To set an alarm

1. On the Home screen, select **Start > Settings > Clock & Alarm > Alarm**.
2. In **Alarm time**, enter the time for the alarm to go off.
2. In **Alarm**, choose when you want the alarm to go off.
4. Select **Done**.

## Set personal information

Entering and displaying owner information are best practices; they allow someone to return the phone to you in case it is lost.

### To enter owner information

1. On the Home screen, select **Start > Settings > More > Owner Information**.
2. Enter the necessary information and select **Done**.

## Set performance and maintenance options

### To change accessibility settings

1. On the Home screen, select **Start > Settings > More > Accessibility**.
2. Select your preference for the following:
  - In **System font size**, set the size of the font that is displayed on the screen.
  - In **Multipress time out**, set the length of time between keypresses when entering text in Multipress mode.
  - In **Confirmation time out**, set the delay before an unconfirmed action times out.
  - In **In-call alert volume**, set the volume for incoming call or receiving new message alerts while you are in a call.
3. Select **Done**.

### To change power management settings

You can use Power Management to check the battery, and configure settings that prolong battery life.

1. On the Home screen, scroll down to  on the Shortcuts Bar, then select **Manage Battery**.
2. Adjust the following settings:
  - In **Backlight time out on battery / AC**, select the amount of time for the phone to be idle before the backlight turns off when using the battery or AC power.

- In **Display time out on battery / AC**, select the time limit for the phone to be idle before the screen turns off when using the battery or AC power.
- In **When device is turned on, do not charge the battery when connected to PC**, select **On** if you do not want to charge the battery when the device is connected to the computer.

3. Select **Done**.

**Tip** **Main battery** indicates the amount of battery life remaining.

#### **To find the operating system version number**

On the Home screen, select **Start > Settings > About**.

#### **To find the phone specification**

On the Home screen, select **Start > Settings > System Information**.

## 4.2 Adding and Removing Programs

Before you purchase additional programs for your phone, make sure that they are compatible with your phone.

#### **To add programs**

1. Download the program to your PC (or insert the disc that contains the program into your PC). You may see a single \*.exe file, a \*.zip file, a Setup.exe file, or several versions of files for different device types and processors. Be sure to select a program designed for your phone and processor type.
2. Read the installation instructions that comes with the program.
3. Connect your phone to the PC and then double-click the \*.exe file.



**To remove a program**

1. On the Home screen, select **Start > Settings > More > Remove Programs**.
2. Scroll to the program to remove and then select **Menu > Remove**.

## 4.3 Using Task Manager and Managing Memory

**To check how much memory is available**

1. On the Home screen, select **Start > Settings > More > About**.
2. Scroll down to **Available Memory**.

**To close running programs in Task Manager**

Task Manager allows you to close programs currently running on your phone to free up storage space.

1. On the Home screen, scroll down to  on the Shortcuts Bar, then select **Manage Memory**.
2. On the Task Manager screen, select **Menu** to open a list that lets you go to a specific program, stop running programs, and view system information.
3. Choose a program on the list and select **Menu > Stop**.

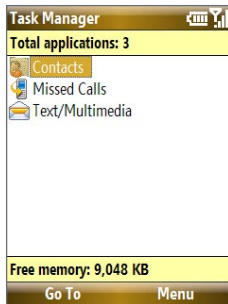

## 4.4 Managing and Backing Up Files

You can back up files to your PC using Windows Mobile Device Center or ActiveSync or copy files to a storage card that is installed on your phone. You can also efficiently manage your files and folders using File Explorer installed on your phone.

### Copy files using Windows Mobile Device Center/ ActiveSync to the PC

1. Connect your phone to your PC.
2. In Windows Mobile Device Center, click **File Management > Browse the contents of your device.**  
Or  
In ActiveSync on your PC, click **Explore**. This opens the Mobile Device folder for your phone.
3. Browse your phone for files that you want to copy to your PC.
4. Select and copy the files [**Ctrl + C**] and then paste them [**Ctrl+V**] to the destination folder in the PC.

Copying a file results in separate versions of a file on your phone and PC. Changes made to one file will not affect the other since the files are not synchronized.

### Use File Explorer

File Explorer provides many easy-to-use features for file and folder management.

#### To start File Explorer

On the Home screen, select **Start > File Explorer**.

File Explorer operates in the following two views:

- List View
- Icons View

File Explorer displays the entire file structure in your phone's memory. The functions focus primarily on folder management. When initially started, File Explorer is in List View by default. To switch between views, select **Menu > View > Icons** or **List**.

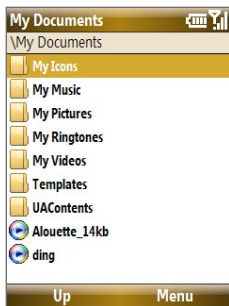

File Explorer - List View



File Explorer - Icons View

In File Explorer, select **Menu** to open a list that lets you send or beam the file, view the file's properties, sort the files, and more.

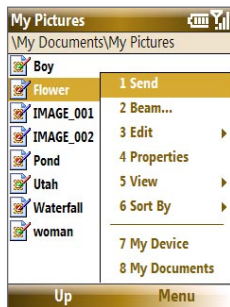

### To send a file as an e-mail attachment

1. In File Explorer, select a file and select **Menu > Send**.
2. On the Messaging screen, select an e-mail account.
3. The file will automatically be attached to the new message. Specify the recipient and subject, and type your message.
4. Select **Send**.

**Note** You can also send the file via Picture Message.

## 4.5 Protecting Your Phone

You can protect your phone from unauthorized use by requiring a PIN (personal identification number) in order to make calls. Your default PIN is **1234**. Additionally, you can also lock the entire phone.

### To enable the SIM PIN

1. On the Home screen, select **Start** > **Settings** > **Security** > **Enable SIM PIN**.
2. Enter the PIN, and select **Done**.

**Note** To cancel without enabling the SIM PIN, press **HOME**.

### To disable the SIM PIN

1. On the Home screen, select **Start** > **Settings** > **Security** > **Disable SIM PIN**.
2. Enter the PIN, and select **Done**.

### To change the SIM PIN

Be sure to make a note of your personal identification number (PIN). When the SIM PIN is enabled, you must provide this PIN to unlock the phone.

1. Select **Start** > **Settings** > **Security** > **Change SIM PIN**.
2. In **Old PIN**, enter the current PIN.
3. Enter and confirm the new PIN, and select **Done**.

### To lock the phone

Locking the phone turns off its functionality. This is a helpful feature if, for example, the phone is turned on and in your pocket, and you want to prevent accidental keypresses. Once the phone is locked, the left **SOFT KEY** label changes to **Unlock**.

You can lock the phone by:

- Press and hold  for about 2 seconds.
- Close the keyboard, then select **Yes**.

**Note** The **Manual lock** option must be enabled. See "To set keyboard lock options" for details.

- Press and hold the **HOME** key to open the Quick list, then select **Lock**.

**Note** You can still receive calls and make emergency calls when the phone is locked.

### To automatically enable phone lock

1. On the Home screen, select **Start > Settings > Security > Device lock**.
2. Select **Prompt if device unused for** then select the amount of time for the phone to be inactive before automatically locking.
3. Select the **Password type**, then enter and confirm your password.
4. Select **Done**.

### To unlock the phone

Depending on whether the keyboard is opened or closed, you can unlock the phone by:

- Select **Unlock** and press the **HOME** key.
- If the keyboard is closed, open the keyboard.

**Note** If a password has been enabled, you will be prompted for the password when you unlock the phone.

### To disable the phone lock

Select **Unlock** and then enter the password you have set to unlock your phone.

### To set keyboard lock options

1. Select **Start > Settings > Slide and Key Lock**.
2. Choose to enable or disable **Auto lock timeout** and/or **Manual lock**.
  - Enabling **Auto lock timeout** locks the phone the same time the backlight goes off, if set in Power Management, when the keyboard is closed.
  - Enabling **Manual lock** prompts a message if you want to lock the phone or not when you close the keyboard.

### To encrypt files on the microSD card

Select **Start > Settings > Security > Encryption** and choose **Encrypt files placed on storage cards**.

## 4.6 Restarting Your Phone

Restart your phone when a program is not performing properly or the phone is not responding to any keypresses.

### To restart the phone

1. Remove the battery.
2. Wait 3 seconds, then reinsert the battery and turn on your phone.

**WARNING!** If the phone is restarted while a program is running, unsaved work will be lost.

## 4.7 Resetting Your Phone

Resetting your phone will remove all the data from its memory and restore the phone back to the factory default settings.

**WARNING!** All your data will be deleted, it is recommended that you back up your data first before resetting your phone.

### To reset your phone

1. Select **Start > Accessories > Clear Storage**.
2. Follow the on-screen instructions to reset the phone.

The phone will restart after it has been reset.

**Note** If **Encrypt files placed on storage cards** is or was enabled before, then backup all files from the storage card before using Clear Storage, hard reset or updating the ROM system software. Otherwise you will no longer be able to access the encrypted files on the storage card. Use ActiveSync or Windows Mobile Device Center to transfer files between your storage card and computer. After the procedure, copy your files back to the storage card.

## 4.8 Windows Update

Link to Microsoft's Web site and update Windows Mobile® on your phone with the latest security patches or fixes.

### To set up Windows Update

The first time you run Windows Update, you need to set up how you want Windows Update to check for patches on the Microsoft Web site.

1. Select **Start > Settings > More > Windows Update**.
2. On the Update Setup screen, select **Next**.
3. Select how you want to check for updates, **Manual** or **Automatic**, then select **Next**.

**Note** If you select **Automatic**, choose whether or not to use your data plan to check for updates.

4. Select **Finish**.



### To change Windows Update options

1. Select **Start > Settings > More > Windows Update**.
2. Select **Menu** and choose the option you want to change.
  - Choose **Connections** to change how the device connects to the Internet when checking for updates.
  - Choose **Change Schedule** to change how Windows Update checks for patches on the Microsoft Web site.

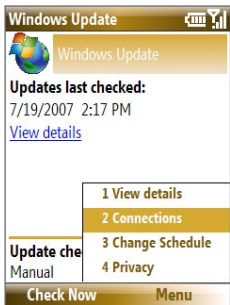

**Tip** You can check for updates whenever you want by selecting **Check Now** on the Windows Update screen.





# Chapter 5

## Organizing Phone Information

**5.1 Contacts**

**5.2 SIM Manager**

**5.3 T-Mobile® myFaves<sup>SM</sup>**

**5.4 Calendar**

**5.5 Tasks**

**5.6 T-Mobile Address Book**

**5.7 Voice Recorder**

**5.8 Voice Notes**

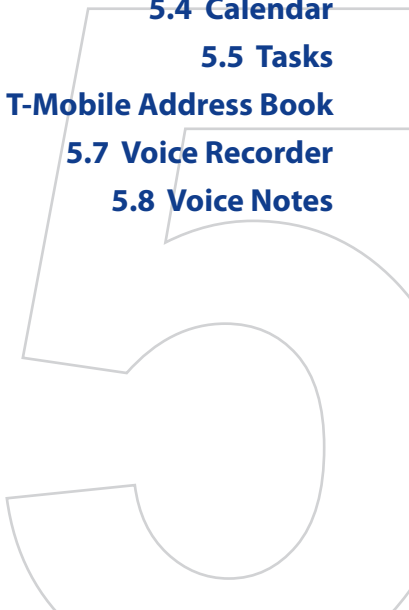

## 5.1 Contacts

Contacts is your address book and information storage for the people and businesses you communicate with.

If you use Outlook on your PC, you can synchronize contacts between your phone and PC.

### Create a contact on your phone

#### To create a new contact on your phone

1. On the Home screen, **Start > Contacts > New > Outlook Contact**.

To create a new contact on your SIM card, select **SIM Contact**. You can also use SIM Manager to add contacts to your SIM card. For more information about SIM Manager, see “SIM Manager” in this chapter.

2. Enter information for the new contact.
  - To easily identify who is calling you, you can assign a custom ring tone to each Outlook contact. To assign a custom ring tone, scroll down to and select **Custom ring tone** and select the ring tone you want.
  - To assign a picture to a contact, scroll down to **Picture** and select **Select a picture** and choose the picture you want. To remove the picture, select **Menu > Remove Picture**.
3. Select **Done**.

**Tip** If someone who is not in your list of contacts calls you or sends you a message, you can quickly create a contact from Call History or from the message by selecting **Menu > Save to Contacts**.

### Edit and call a contact

#### To view and edit a contact information

1. On the Home screen, select **Start > Contacts**.
2. Select the contact whose information you want to view or edit and select **Menu > Edit**.
3. When finished making changes, select **Done**.

### To call a contact from the contact list

1. On the Home screen, select **Start > Contacts**.
2. Select the contact to call and press . The contact's default phone number is dialed.

**Tip** To call a phone number other than the default, select the contact, scroll to the number you want to dial, and press .

## Find a contact

### To find a contact

1. On the Home screen, select **Start > Contacts**.  
**Note** If you are not in Name view, select **Menu > View By > Name**.
2. Do one of the following:
  - Begin entering a name or phone number of the contact until the contact is displayed. When you press a key, such as **5**, you find names that begin with **G** and **H**, as well as phone numbers that start with **5**. The next key you press continues to narrow the search.
  - If you have assigned categories (e.g. Business) to your Outlook contacts, you can filter the contact list by categories. In the contact list, select **Menu > Filter** and then select a category. To show all contacts again, select **All Contacts**.
  - If you have entered information under **Company** for your Outlook contacts, you can quickly locate the contacts that work for a specific on your phone. In the contact list, select **Menu > View By > Company**. Select the company to see the contacts who work there.

## Share contact information

### To beam contact information to another device via Bluetooth

1. On the Home screen, select **Start > Contacts** and then select the contact whose information you want to beam.
2. Select **Menu > Send Contact > Beam**.
3. Select the device where you want to beam the contact details to and select **Beam**.

**Note** Before you can beam, make sure Bluetooth is turned on and set to **Visible** mode on your phone and the target mobile device. For more information, see “Bluetooth” in Chapter 8.

### To send contact information via a text message

1. On the Home screen, select **Start > Contacts** and then select the contact whose information you want to send.
2. Select **Menu > Send Contact > Text/Multimedia**. Select the contact information that you want to send and select **Done**.
3. In the new text message, enter the mobile phone number of the person to whom you are sending the contact information to and select **Send**.

### To send contact information via Picture Message

1. On the Home screen, select **Start > Contacts**.
2. Select a contact, then select **Menu > Send as vCard**.
3. Enter the recipient in **To** of the Picture Message, then select **Send**.

If the recipient accepts the beam, text message, or Picture Message, the contact information you sent are automatically saved in that person’s Contacts list.

## 5.2 SIM Manager

SIM Manager allows you to view the contents of your SIM card and transfer contacts from your SIM card to your phone and vice versa.

### To create a contact on your SIM card

1. Select **Start > Accessories > SIM Manager**.
2. Select **New** and enter the contact name and phone number.
3. Select **Save**.

**Tip** To change contact information on your SIM card, select a contact and edit it. After modifying, select **Save**.

### To copy SIM contacts to your phone

1. Select **Start > Accessories > SIM Manager**.
2. Select a SIM contact or select all SIM contacts by selecting **Menu > Select All**.
3. Select **Menu > Save to Contacts**.

### To copy phone contacts to the SIM card

Only one phone number per contact name can be stored on a SIM card. When you copy a contact that has several phone numbers to your SIM card, SIM Manager saves each number under a separate name.

To save each number under a different contact name on the SIM card, SIM Manager appends an indicator at the end of each name. You can edit this indicator first before you start copying contacts to your SIM card.

1. Select **Start > Accessories > SIM Manager > Menu > Tools > Options**.
2. On the Options screen, select the check boxes of the types of phone numbers that you want to be added to the SIM card.
3. Under the **Mark** column, you can change the indicator that will be appended to the SIM contact names for each phone number type. To do so, select a phone type, select **Edit**, enter your desired indicator, then select **Save**.

4. After modifying, select **OK**.
5. Select **Menu > Contacts to SIM**.
6. Select the check boxes of the contact's phone numbers that you want to copy to your SIM card, then select **Save**.

### To display your phone number in SIM Manager

1. On the SIM Manager screen, select **Menu > Tools > List of Own Numbers**.
2. Select **Edit**.
3. Change the name, if desired, then enter your mobile phone number.
4. Select **Save**.

When your phone number is stored on the SIM card, it will appear on the SIM Manager screen.

The screenshot shows the SIM Manager interface. At the top, it says 'SIM Manager' with a signal strength icon. Below that, it displays 'My No. 0988'. A table lists contacts with columns for '#', 'Name', and 'Phone'. The first contact is '1 Alex 1111111' and the second is '2 Brad 2222222'. At the bottom, there are 'New' and 'Menu' buttons.

#	Name	Phone
1	Alex	1111111
2	Brad	2222222

## 5.3 T-Mobile® myFaves<sup>SM</sup>

T-Mobile® myFaves<sup>SM</sup> helps you stay connected to the people who matter most in your life. Simply choose any five U.S. phone numbers you call most often, on any network, and have them displayed on your phone's main screen.

For more information about the benefits of using T-Mobile® myFaves<sup>SM</sup> and how to subscribe to this service, visit <http://www.t-mobile.com>.

## T-Mobile myFaves<sup>SM</sup> on the Home screen

Once your subscription to T-Mobile® myFaves<sup>SM</sup> service has been activated, myFaves will show on your phone's Home screen. You can add and call contacts by simply selecting the circles you see on the Home screen when you have the myFaves<sup>SM</sup> icon (  ). You can also associate your contacts with preset icons or their actual photos.

**Note** A notification icon appears on the bottom-right side of the myFaves contact if there is a new message and/or missed call from that myFaves contact.



Notification icons

Turn the **NAVIGATION WHEEL** to go through your myFaves contacts and then press **CENTER SELECT** to add, call, edit or view a contact.

### Add myFaves contacts

To add myFaves contacts, you can create new contacts or add existing contacts from your phone or SIM card.

1. Select an empty circle on the Home screen.
2. Choose whether to create a new contact or use an existing contact.

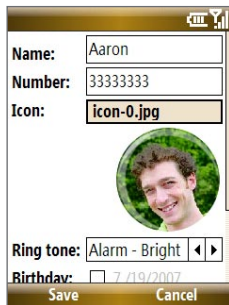
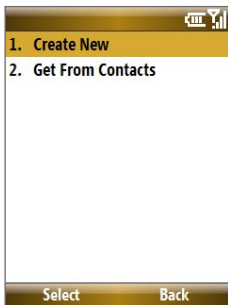

**Note** If you choose **Create New**, you need to fill in the **Name** and **Number**.

- Under **Icon**, select **Change icon** to associate the contact with an image. You can choose to take a picture, download from the T-Mobile site or use an existing image or icon on your phone.

**Tip** When using a photo taken by the phone's camera as a photo for a myFaves contact, you can rotate the photo by selecting **Options > Rotate**.

- Set a **Ring tone** for the contact.
- Select the **Birthday** and/or **Anniversary** reminder check boxes according to your preference and enter the date.
- Set a **Reminder** for each event. On the day of the reminder, a screen will open letting you quickly call, send a text message, or buy a gift for the contact.
- Select **Save**. In the Confirmation screen, select **Yes**.
- Select **OK** in the two succeeding screens.

## Call a myFaves contact

- On the Home screen, select the myFaves contact you want to call.
- On the Profile screen, select **Call**.

You can also choose to send the contact an e-mail, text message, instant message, multimedia message, or voice note.

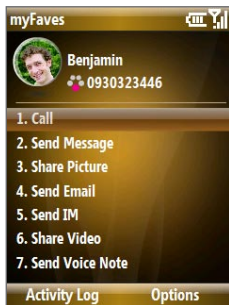

Menu Style: List

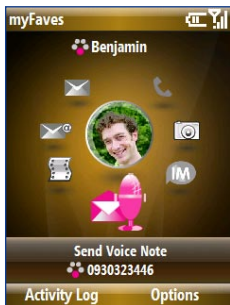

Menu Style: Circle



You can change the menu style by selecting **Options > myFaves Settings > Menu Style**.

### To view the activity log of the contact

Select **Activity Log** on the Profile screen to view the activity log of the selected contact. From the Log screen, you can read a new text message, view/reply a missed call, play a voice note, and more.

To open the item, press **CENTER SELECT**.

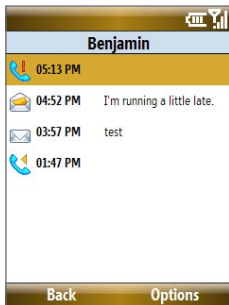

### Edit a myFaves contact

1. On the Home screen, select the myFaves contact you want to edit then select **Options**.
2. In the Options menu, select one of the following:
  - **Edit Profile.** Modify the contact's name, phone number or photo.
  - **Edit Email.** Add or change the e-mail address of the selected contact.
  - **Replace Contact.** Replace with another contact.
  - **Set As Favorite.** Set the current contact as your primary myFaves contact. It will appear as your first myFaves contact on the Home screen, and will also be selected automatically whenever you launch the myFaves program.
  - **myFaves Settings.** Set myFaves options such as the display mode and menu style. You can also download myFaves icons and refresh the myFaves page.

**Tip** You can also access the **myFaves Settings** option by selecting **Start > myFaves** on the Home screen.

## 5.4 Calendar

Use Calendar to schedule appointments, including meetings and other events. If you use Microsoft® Office Outlook® on your PC, you can synchronize appointments between your phone and PC.

### Create a personal appointment

#### To set Calendar options

1. On the Home screen, select **Start > Calendar**.
2. Select **Menu > Tools > Options**.
3. Scroll through the available settings and set your desired default options.
4. Select **Done**.

#### To schedule an appointment

1. On the Home screen, scroll down to  on the Shortcuts Bar, then select **New Appointment**.
2. Enter information about the appointment.
  - To schedule an all-day event, in **End time**, select **All day event**.
  - To make the appointment recurring, select **Occurs**.
3. Select **Done**.

**Note** All-day events do not occupy blocks of time in Calendar; instead, they appear in banners at the top of the calendar.

### View your appointments

#### To view your schedule

You can view your schedule in three different views: Month, Week, and Agenda.

1. On the Home screen, select **Start > Calendar**.
2. Press the left **SOFT KEY** or select **Menu** and choose the view you want.

Highlighted areas represent time segments that have scheduled appointments.

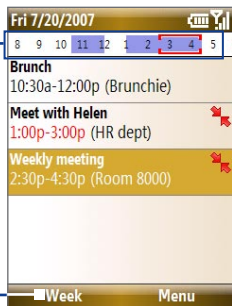

Select an item to view the details of the appointment.

Select to change the view.

### Agenda View

An appointment with the  icon indicates that the scheduled appointment has a conflict with one or more existing appointments.

## Send appointments

### To send a meeting request

You can send meeting requests via e-mail to persons that use Microsoft® Office Outlook® or Microsoft® Office Outlook® Mobile.

1. Select **Start > Calendar**.
2. Schedule a new appointment and then scroll down to **Attendees** and select **No Attendees**.  
Select **Add Required Attendee** or **Add Optional Attendee** to add the contacts you want to send the meeting request to.  
**Note** You can only specify if an attendee is required or optional if your phone is connected to a Microsoft Exchange 2007 server. Otherwise, all attendees are designated as required. For more information, see Chapter 7.
3. Choose the contact(s) you want to send the meeting request to and select **Select**.  
**Note** To remove an attendee from the list, select the attendee and select **Menu > Remove Attendee**.
4. On the New Appointment screen, select **Done**. The meeting request is sent out.

**Note** When attendees accept your meeting request, the meeting is automatically added to their schedules. When their response is sent back to you, your calendar is updated as well.

### To send a calendar appointment

You can send a calendar appointment to another phone over Picture Message.

1. On the Home screen, select **Start > Calendar**.
2. Select an appointment, then select **Menu > Send as vCalendar**.
3. Enter the recipient in the **To** line of the Picture Message, then select **Send**.

## 5.5 Tasks

Use Tasks to keep track of things you need to do.

### To create a task

1. On the Home screen, select **Start > Tasks**.
2. Select **Menu > New Task**.
3. Enter the necessary task information and select **Done**.
  - Set a **Priority** for the task. This item can be referenced when sorting tasks.
  - Enter a **Start date** and **Due date** if the task starts and ends at a specific time.
  - Enter a **Reminder** if you want to be notified if the task is due.
  - Enter the **Categories** (you can set more than one) that best describes the task. This item can be referenced when filtering tasks.

### Notes

- You can synchronize information on your phone with your PC to keep your task list up to date in both locations.
- If you create a new task with a reminder on your PC and then synchronize tasks with your phone, the reminder will play at the time that was set on your PC.

### To locate a task

1. On the Home screen, select **Start > Tasks**.
2. In the task list, do one of the following:
  - To sort the list, select **Menu > Sort by**, and select a sort option.
  - To filter the list by category, select **Menu > Filter**, and choose the category you want displayed.

### To mark a task as completed

1. On the Home screen, select **Start > Tasks**.
2. Select the task, and select **Complete**.

## 5.6 T-Mobile Address Book

T-Mobile Address Book is a tool that lets you back up and synchronize your Contacts, Tasks, and Calendar items on your phone with the T-Mobile web site. You need an active connection (e.g. EDGE) for you to use T-Mobile Address Book.

### To set up T-Mobile Address Book

1. Select **Start > T-Mobile Address Book**.
2. Select **Yes** to begin the setup process.

You will then be asked to copy SIM contacts to your phone first, since T-Mobile Address Book only allows contacts that are stored on your phone to be synchronized with the T-Mobile web site. Select **Yes** to copy.

**Note** If your phone has existing contact entries, you will be asked if you want to replace the them with the SIM card contact entries or merge the SIM card contact entries with the phone contact entries.
4. To include calendar appointments and tasks when synchronizing with the T-Mobile web site, select **Menu > Sync Options** and then check the **Calendar** and **Tasks** boxes.
5. Select **OK**.

### To synchronize with the T-Mobile Web site

On the T-Mobile Address Book screen, select **Sync**.

### To view synchronization history

On the T-Mobile Address Book screen, select **Menu > History**.

## 5.7 Voice Recorder

Use Voice Recorder to create short voice recordings. Voice recordings are included in the All Notes list and are named consecutively (Recording1, Recording2, and so on).

### To create a voice recording

1. On the Home screen, select **Start > Accessories > Voice Recorder**.
2. Hold the phone's microphone near your mouth.
3. Select **Record** and say your voice recording.
4. Select **Stop** to stop recording a voice recording.

### To delete a voice recording

1. On the Home screen, select **Start > Accessories > Voice Recorder**.
2. Select the voice recording to delete and select **Menu > Delete**.
3. Select **Yes**.

**Tip** If you delete a voice recording that has a default name, such as Recording1, this name becomes available for a new voice recording.

### To listen to a voice recording

1. On the Home screen, select **Start > Accessories > Voice Recorder**.
2. Select the voice recording to play, and press **CENTER SELECT**.

**Tip** To stop listening to the voice recording, select **Stop** while the voice recording is playing.

### To use a voice recording as a ring tone

1. On the Home screen, select **Start > Accessories > Voice Recorder**.
2. Select the voice recording, and select **Menu > Set As Ringtone**.

## 5.8 Voice Notes

Voice Notes lets you record a voice clip and quickly send it via Multimedia Messages.

### To record a voice clip

1. On the Home screen, scroll down to  on the Shortcuts Bar, then select **Voice Notes > Compose**.
2. Hold the phone's microphone near your mouth.
3. Select **Record** to start recording your voice clip. You can select **Pause** to temporarily stop recording. When you want to continue recording, select **Resume**.
4. Select **Stop** to stop recording.  
**Note** Select **Menu > Play** to play back the recorded voice clip. If you are not satisfied with the recording, select **Menu > Record Again**.
5. Select **Send** to automatically open the Multimedia Message program with the voice note file automatically inserted as the audio file for the Picture Message.





# Chapter 6

## Exchanging Messages

**6.1 Messaging**

**6.2 Text Messages**

**6.3 Picture Messages**

**6.4 Using Instant Messaging**

**6.5 Set Up E-Mail**

**6.6 Using E-mail**

**6.7 Using Keyboard Shortcuts**

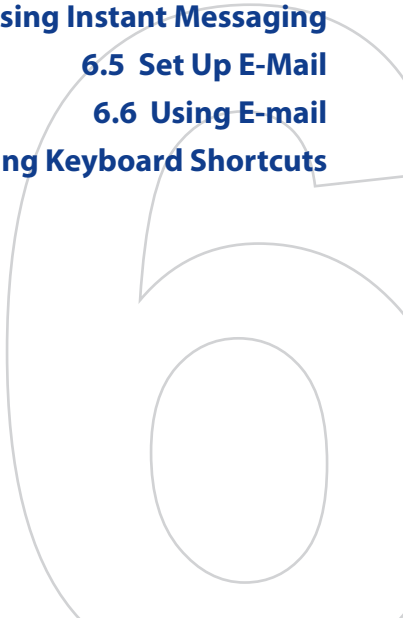

## 6.1 Messaging

Messaging is where all of your e-mail, text message, and Picture Message accounts are located. When you receive a new message, you can open that particular message from the Home screen. Simply scroll down to the **Notifications** icon on the Shortcuts Bar then select the message.

To access your message accounts, select **Start > Messaging** and then select the account you want to open.

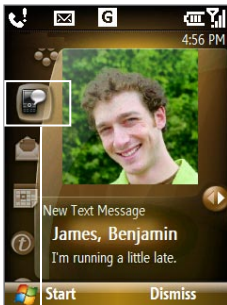

Notifications icon on the Shortcuts Bar.

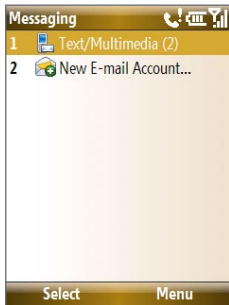

Messaging screen

While in a messaging account's main screen, select **Menu > Tools > Switch Accounts** to switch to another message account.

### To change message account settings

- On the Messaging screen, select the message account whose settings you want to change and select **Menu > Settings**.
- On a message account's message list, select **Menu > Tools > Options**.

## 6.2 Text Messages

Send short text messages to your contacts.

### Compose and send text messages

#### To compose and send a text message

1. On the Home screen, scroll down to  on the Shortcuts Bar, then select **Text Messages > Compose**.
2. Enter the mobile phone number of one or more recipients, separating them with a semicolon (;). To access phone numbers from Contacts, in **To**, press **CENTER SELECT** and select a recipient from the list.
3. Enter your message. You can enter up to 160 characters in one message.
4. Select **Send**.

#### Tips

- To cancel the text message, select **Menu > Cancel Message**.
- If you want to know if your text message was received, before sending the message, select **Menu > Message Options** and select **Request message delivery notification**.

### Receive text messages

Text messages are automatically received when the phone function is turned on. When the phone is turned off, text messages are held by T-Mobile until the next time the phone is turned on.

- Save your SMS messages to your SIM card by selecting **Menu > Copy to SIM**.
- Copy SMS messages saved on your SIM card to the Inbox by selecting **Menu > Copy to Inbox**. Copying them to your phone results in duplicate messages in the Inbox folder when the SIM card is in use.
- The icon  next to a message indicates that it is saved on the SIM card.

## 6.3 Picture Messages

Sending Picture Messages (MMS) to your friends and family is fun and easy. You can include pictures, video, and an audio clip in a picture message.

### To access Picture Messages

On the Home screen, scroll down to  on the Shortcuts Bar, then select **Picture Messages**.

**Note** When you purchase your phone, it is already preset with T-Mobile's Picture Message settings. If you accidentally lost the preset settings or you want to add another wireless service provider, you can configure the settings while composing a Picture Message.

### Create and send Picture Messages

You can compose Picture Messages in a combination of various slides, where each slide can consist of a photo, audio or video clip, and/or text.

#### To start composing a Picture Message

1. On the Home screen, scroll down to  on the Shortcuts Bar, then select **Picture Messages > Compose**.
2. In **To**, enter the recipient's phone number or e-mail address .
3. In **Subject**, enter a subject for your message.
4. Select **Insert Picture/Video** to select a photo or video clip from the Select Media screen and insert it.  
To capture a new photo or video, select **Menu > Capture Picture/Video**.



**Tip** After inserting a Picture message element, press **NAVIGATION** right to add a new slide.

5. Select **Insert Text** to enter text for your Picture message.
  - To insert predefined text or emoticons, select **Menu > My Text or Insert Emoticon**.

- To insert contact details of a contact or appointment details, select **Menu > Insert Contact** or **Insert Calendar**. You can then choose the details that you want to insert.
- 6. Select **Insert Audio** to insert an audio clip. Select an audio clip on the Select Audio screen.  
To record a new audio clip, select **Menu > Capture Audio**
- 7. Select **Send** to send the message.

### Notes

- To send a copy of this message to others, access **Cc** and **Bcc** by selecting **Menu > Options > Send Options**.
- To remove the photo, text, or audio, select the item and press the **BACK** key.

## View, reply to and block Picture Messages

### To receive Picture Messages

On any Picture message folder screen, select **Menu > Send/Receive**. By default, messages are automatically downloaded to your phone.

### To view a Picture Message

You can view Picture Messages in several ways.

- Press **CENTER SELECT** to view and play the message on your phone. Select **Pause** or **Menu > Stop** to pause or stop the playback of the message.
- Select **Menu > Object View** to see a list of files included in the message. To open a file, select it and select **Open**. To save a file, select it, and select **Save**, **Menu > Save Audio**, or **Menu > Save Photo**.
- View each slide included in the message by selecting **Menu > Next**.

### To reply to a Picture Message

Select **Menu > Reply > Reply** to reply to the sender of the message, or select **Menu > Reply > Reply All** to reply to all persons listed in the To and CC boxes of the message. Select **Menu > Reply > Forward** to forward the message to someone else.

### To block a phone number from sending you Picture Messages

You can choose to block a phone number from sending you Picture messages if you do not want to receive future Picture messages from that number.

1. View the Picture Message then select **Menu > Show Message Details**.
2. In the MMS Details screen, select the contact in the **From** field then select **Menu > Open**.
3. Select the number on the screen and press **CENTER SELECT**. On the menu that opens, select **Save to Blacklist**.

**Note** By adding the number to the Blacklist, you will not receive future Picture messages from that number. To edit the MMS Blacklist, on a Picture Message, select **Menu > Options > Message Options > Menu > Edit Blacklist**. Here you can remove a number from the Blacklist.

## 6.4 Using Instant Messaging

### AIM®

You will need an AIM® account to use instant messaging. To set up an account, go to <http://www.aim.com/t-mobile>.

#### To sign on

1. On the Home screen, select **Start > Instant Messaging**.
2. Select **AOL Instant Messenger**.
3. Type your screen name and password. Note that your password is case-sensitive.
4. Scroll to **Save password** and **Auto-Sign On** and press **CENTER SELECT** to place checks in the check boxes, if desired.
5. Select **Sign On**.

#### To sign off

1. At Buddy List®, select **Menu > Sign Off**.
2. Select **Yes**.

**To add a buddy**

1. At Buddy List®, select **Menu > Add Buddy**.
2. Type your buddy's screen name and select **Add**.

**To delete buddy**

1. At Buddy List®, scroll to the buddy you want to delete.
2. Select **Menu > Delete Buddy**.
3. Select **Yes**.

**To send message to buddy**

1. At Buddy List®, scroll to and select the buddy you want to send a message.
2. Select **Menu > Send IM**.
3. Type your message and select **Menu > Send IM**.

**To send message to unlisted buddy**

1. At Buddy List®, select **Menu > Send IM to**.
2. Type your buddy's screen name and select **OK**.
3. Type your message and **Menu > Send IM**.

**To block buddy**

1. At Buddy List®, scroll to the buddy you want to block.
2. Select **Menu > Block**.
3. Select **Yes**.

**To set away status**

1. At Buddy List®, select **Menu > My Status**.
2. Scroll to and select **Away**.

**ICQ®**

You will need an ICQ account to use instant messaging. To set up an account, go to <http://www.icq.com>.

**To sign on**

1. On the Home screen, select **Start > Instant Messaging**.
2. Scroll to and select **ICQ®**.

3. Type your ICQ® number and password. Note that your password is case-sensitive.
4. Scroll to **Save password** and **Auto-Sign On** and press **CENTER SELECT** to place checks in the check boxes, if desired.
5. Select **Connect**.

#### To sign off

1. At contact list, select **Menu > Disconnect**.
2. Select **Yes**.

#### To add contact

1. At contact list, select **Menu > Add User**.
2. Type the contact's ICQ® number and nickname.
3. Select **Add**.

#### To delete contact

1. At contact list, scroll to the contact.
2. Select **Menu > Delete User**.
3. Select **Yes**.

#### To send message to a contact

1. At contact list, scroll to the contact.
2. Select **Menu > Send message**.
3. Type your message and select **Menu > Send message**.

#### To send message to unlisted contact

1. At contact list, select **Menu > Send message to**.
2. Type the contact's ICQ® number and select **OK**.
3. Type your message and select **Menu > Send message**.

#### To block contact

1. At contact list, scroll to the contact you want to block.
2. Select **Menu > Block**.
3. Select **Yes**.



**To set away status**

1. At contact List, select **Menu > My Status**.
2. Scroll to and select **Away**.

**Yahoo!®**

You will need a Yahoo!® account to use instant messaging. To set up an account, go to <http://messenger.yahoo.com>.

**To sign in**

1. On the Home screen, select **Start > Instant Messaging**.
2. Scroll to and select **Y! Messenger**.
3. Type your Yahoo! ID and password. Note that your password is case-sensitive.
4. Scroll to **Save password** and **Auto-Sign On** and press **CENTER SELECT** to place checks in the check boxes, if desired.
5. Select **Sign In**.

**To sign out**

1. At contact list, select **Menu > Sign Out**.
2. Select **Yes**.

**To add contact**

1. At contact list, select **Menu > Add Contact**.
2. Type the contact's Yahoo! ID and select **Add**.

**To delete contact**

1. At contact list, scroll to the contact you want to delete.
2. Select **Menu > Delete Contact**.
3. Select **Yes**.

**To send message to contact**

1. At contact list, scroll to the contact you want to send a message.
2. Select **Menu > Send a Message**.
3. Type your message and select **Menu > Send Message**.

**To send message to unlisted contact**

1. At contact list, select **Menu** > **Send a Message to**.
2. Type the contact's Yahoo! ID and select **OK**.
3. Type your message and select **Menu** > **Send Message**.

**To set away status**

1. At contact List, select **Menu** > **My Status**.
2. Scroll to and select **Away**.

## 6.5 Set Up E-Mail

**Set Up E-Mail** provides you unlimited access to your work and personal email. Instantly access your e-mail from AOL®, Yahoo!®, Gmail®, Microsoft® Exchange and many more, including any POP3 or IMAP4 e-mail server.

**Note** Restrictions may apply. Contact your e-mail provider for additional information.

### To add e-mail accounts using Set Up E-mail

1. On the Home screen, scroll down to  on the Shortcuts Bar, then select **Set Up E-mail**.
2. On the Select Account screen, select the type of e-mail accounts you want to add to your device.

**Tip** Select  if you need more help in setting up an e-mail account.



### To set up AOL/AIM Mail, Yahoo! or Gmail

Select **AOL/AIM Mail**, **Yahoo!**, or **Gmail**, then simply enter your e-mail address and password.

### To set up Windows Live Mail

Select **Windows Live**, then sign in using your Windows Live ID. See Chapter 8 for details.

### To set up Outlook E-mail

1. On the Select Account screen, select **Outlook E-mail**.
2. To send and receive personal e-mail on your phone:
  - Check if the synchronization software has been installed on your PC and a sync partnership has been created with your phone. If these have been done, then just connect your phone to your PC to send and receive Outlook e-mails.  
If you have not yet installed the synchronization software nor created a partnership, please do so by following the procedures in Chapter 3.
3. To set up your company e-mail account on your phone:
  - Set up your phone to synchronize via a wireless LAN or over-the-air connection with your company's Exchange Server. For more information about synchronizing with the Exchange Server, see Chapter 7.

### To set up a POP3 or IMAP4 e-mail account

If you have an e-mail account from an ISP and other Web-based accounts such as Gmail®, add them as POP3 or IMAP4 accounts on your device.

1. On the Select Account screen, select **Other**.
2. Enter your e-mail address and password, then select **Next**.

**Note** If your e-mail provider settings cannot be found, you will be prompted to enter settings such as the incoming and outgoing server names. Ask from your provider about these settings.

### To access your e-mail accounts

Select **Start > Messaging**. You will see your e-mail accounts in the Messaging screen.

## 6.6 Using E-mail

After setting up e-mail accounts on your phone, you can start sending and receiving e-mail messages.

### Create and reply to e-mails

#### To compose and send an e-mail

1. Select **Start > Messaging** then select an e-mail account.
2. Select **Menu > New**.
3. Enter the e-mail address of one or more recipients, separating them with a semicolon. To access e-mail addresses stored in Contacts, select **To**.
4. Enter a subject and compose your message. To quickly add common messages, select **Menu > My Text** and select a desired message.
5. Select **Send**.

#### Tips

- To set the priority, select **Menu > Message Options**.
- If you are working offline, e-mail messages are moved to the Outbox folder and will be sent the next time you connect.

#### To add an attachment to an e-mail

1. In the message that you are composing, select **Menu > Insert** and select the item you want to attach: **Picture**, **Voice Note**, or **File**.
2. Select the file you want to attach, or record a voice note.

### Filter the Inbox message list

Filter the e-mail messages in your Inbox to only display the e-mails that contain the sender or e-mail subject you are searching for.

Enter the sender name or e-mail subject you want to look for using the keyboard. As you press keys, the list narrows down to the conditions you set.

For example, pressing “J” then “A” narrows the list to only the e-mails that contain sender names, e-mail subjects, and/or message body that start with “JA.”

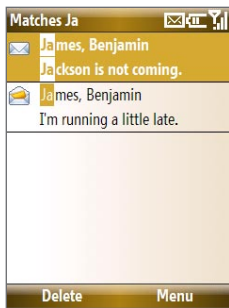

**Note** This feature works for all Messaging accounts.

## View and reply to e-mails

### To read incoming messages

By default, only the first few kilobytes of a message are shown when you open and read an incoming message. To read the whole message, do one of the following:

- Scroll down to the end of the message and select **Get the rest of this message**; or
- Select **Menu > Download Message**.

### To download an attachment

In an open message with an attachment to download, select the attachment. If there is more than one attachment, select the other attachments to download them. You can directly open the file in the associated program after you download them by selecting the attachment again.

### To reply to or forward an e-mail

1. Open the message and select **Menu > Reply > Reply, Reply All, or Forward**.
2. Enter your response. To quickly add common messages, select **Menu > My Text** and select a desired message.
3. Select **Send**.

### Tips

- To see more header information, scroll up.
- To always include the original message, from the list view, select **Menu > Tools > Options > Sending**, and select the **Include copy of original message when replying to e-mail** check box.
- In the Outlook E-mail account, you will send less data if you do not edit the original message. This may reduce data transfer costs based on your rate plan.

### To view and reply to HTML e-mails

You can receive, view and reply to HTML e-mails from any type of e-mail account. The HTML format is retained, without layout shifting or resizing.

**Note** HTML e-mail support in Outlook Mobile is available only if your company is using Microsoft Exchange Server 2007.

1. Set the message format to HTML. To find out how to set the message format, see “Customize e-mail settings”.
2. Select **Start > Messaging**, select your e-mail account, and open an HTML e-mail that you received.
3. Select **Get the rest of this message** that’s shown at the bottom of the message to download the whole message.
4. Scroll up (if needed) and select **Click to scroll right** to be able to scroll sideways and get a complete horizontal view of the message.

**Note** If images do not immediately appear, select **Internet pictures blocked > Download Internet pictures**.

5. Select **Reply** or select **Menu > Reply** and choose whether to reply to the sender(s) or forward the message.
6. Enter your response and select **Send**.

**Tip** E-mail can contain hyperlinks to Web pages.

### Send and download e-mails

The manner in which you send and receive e-mails depends on the type of e-mail account you have.

### To send and receive e-mail for an Outlook account

1. Select **Start > ActiveSync**.

2. Connect your phone to your PC.

Otherwise, connect wirelessly if you are synchronizing Outlook e-mail with your company e-mail server. See Chapter 7 for details.

3. Synchronization automatically begins, and your phone sends and receives Outlook e-mail.

**Tip** You can also manually synchronize anytime by selecting **Sync** in ActiveSync or **Menu > Send/Receive** in Outlook Mobile.

### To send and receive e-mail for a POP3/IMAP4 account

If you have an e-mail account with an ISP or a work account that you access using a VPN server connection, you send and receive messages through a remote e-mail server. Before sending and downloading messages, you first need to connect to the Internet or your corporate network.

1. Select **Start > Messaging** and select your POP3/IMAP4 e-mail account.
2. Select **Menu > Send/Receive**. The messages on your phone and e-mail server are synchronized: new messages are downloaded to the phone Inbox folder, messages in the phone Outbox folder are sent, and messages that have been deleted from the server are removed from the phone Inbox folder.

## Customize e-mail settings

### To change the download size and format for Outlook e-mail

1. Disconnect your phone from the computer.
2. Select **Start > ActiveSync**.
3. Select **Menu > Options**, select **E-mail**, then select **Settings**.
4. On the E-mail Sync screen, set the **Download size limit** and **Message format**.
5. Close ActiveSync and reconnect your phone to the computer.

## To change the download size, e-mail format and other settings for POP3/IMAP4 e-mail

1. Select **Start > Messaging**.
2. Use the up/down **NAVIGATION** to select your POP3 or IMAP4 e-mail account, then select **Menu > Settings**.
3. You can make changes to your e-mail address, user name, password, etc., and customize the following settings:

Options	Description
<b>Automatic Send/Receive</b>	You can select a time interval for connecting to the Internet automatically to send and receive messages.
<b>Download messages</b>	Set the number of days of messages that you want to be downloaded to your phone.
<b>Send/receive when I click Send</b>	By default, messages are immediately delivered when you select <b>Send</b> . If you prefer to save outgoing messages to the Outbox folder first, clear the check box. (In this case, you will need to manually send messages by selecting <b>Menu &gt; Send/Receive</b> ).
<b>Use automatic send/receive schedule when roaming</b>	This allows your phone to data roam when there is a set time interval for connecting to the Internet automatically. Since this may result in higher connection costs, you may want to leave the check box cleared.
<b>When deleting messages</b>	Choose whether to delete messages from the mail server when you delete them on your phone.
<b>Message format</b>	Select HTML or Plain Text.
<b>Message download limit</b>	Select the e-mail download size. If you have large volumes of e-mail, use a lower size or select to download headers only.

4. When you have finished customizing settings, select **Finish**.



### To exclude your e-mail address when replying to all

When you reply to all the recipients of an Outlook e-mail, your own e-mail address will also be added to the recipient list. Customize ActiveSync so that your e-mail address will be excluded from the recipient list.

1. In ActiveSync on your phone, select **Menu > Options**.
2. Select the **E-mail** information type and select **Settings**.
3. Select **Menu > Advanced**.
4. In the **My e-mail addresses** text box, enter your e-mail address.
5. Select **Done**.

## 6.7 Using Keyboard Shortcuts

You can use keyboard shortcuts to quickly access messaging functions, such as reply, forward, etc.

### To see the list of keyboard shortcuts

1. Select **Start > Messaging** and select a messaging account (Text/Multimedia or any e-mail account).
2. While on a message list, press any key.
3. If this is your first time to use keyboard shortcuts, the following Message Tips screen will appear first:

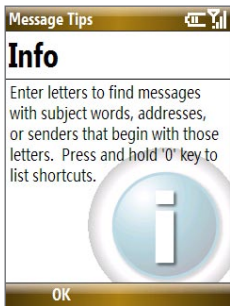

Select **OK** to close the screen.

4. Press and hold the “0” key until the shortcuts list is displayed. Scroll up or down to view the whole list.



#### To use a keyboard shortcut

Press and hold the respective key. For instance, to reply to a message, press and hold **2**.

# Chapter 7

## Working with Company E-mails and Meeting Appointments

**7.1 Synchronizing Your Phone with the  
Exchange Server**

**7.2 Working with Company E-mails**

**7.3 Managing Meeting Requests**

**7.4 Finding Contacts in the Company Directory**

**7.5 E-mail Security**

## 7.1 Synchronizing Your Phone with the Exchange Server

To keep up-to-date with your company e-mails and meeting schedules while you're out of the office, you can connect your phone to the Internet wirelessly and synchronize these information with your company's Exchange Server. You can also access your company address book anytime. Your company must have a mail server that is running Microsoft Exchange Server with Exchange ActiveSync.

Before you can start to synchronize with or access information from the Exchange Server, you need to set up an Exchange Server connection on your phone. You need to get the following information from your network administrator and enter them on your phone: Exchange Server name (must be the Outlook Web Access server name), domain name, and the user name and password that you use at work.

You can set up the Exchange Server connection either from your phone or your PC.

### Set up an Exchange Server connection from your phone

If you have not synchronized your phone with your PC, follow these steps to set up an Exchange Server connection.

1. On the Home screen, scroll down to  on the Shortcuts Bar, then select **Set Up E-mail**.
2. On the Select Account screen, select **Outlook E-mail** then select **Next**.
3. On the ActiveSync screen, select **set up your device to sync with it**.

**Note** If you have previously created an ActiveSync partnership between your phone and PC, skip this step.



4. In **Server address**, enter the Exchange Server name, and select **Next**.
5. Enter your user name, password, and domain, and select **Next**.
6. Select the check boxes of the types of information items that you want to synchronize with the Exchange Server.

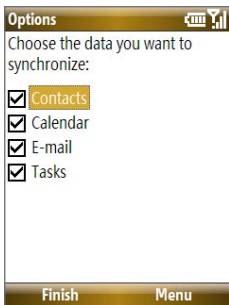
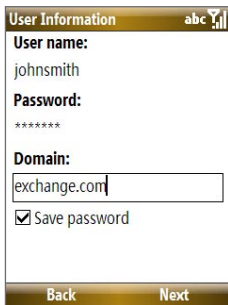

- Tip** To change the rules for resolving synchronization conflicts, select **Menu** > **Advanced**.
7. To change synchronization settings of an information type, for example, E-mail, select the type of information, and select **Menu** > **Settings**.
  8. Select **Finish**.

**Note** If you synchronized e-mails with your PC before, open ActiveSync on your phone and select **Menu > Add Server Source** to set up an Exchange Server connection. When you're prompted to select information types for synchronization, you need to clear the **E-mail** check box under the Windows PC item first before you can select the **E-mail** check box under Exchange Server.

**Tip** To change Exchange Server settings, open ActiveSync on your phone and select **Menu > Configure Server**.

## Set up an Exchange Server connection from your PC

### On a Windows Vista PC

1. Set up synchronization between your PC and phone. See “Set up synchronization in Windows Mobile Device Center” in Chapter 3 for details.
2. Click **Start > All Programs > Windows Mobile Device Center** on your PC.
3. On Windows Mobile Device Center’s Home screen, mouse over **Mobile Device Settings**, click **>>more**, then click **Sync wirelessly with Exchange Server**.



- Enter your company's Exchange Server address, your username, password, and domain.
- Click **Set Up**.

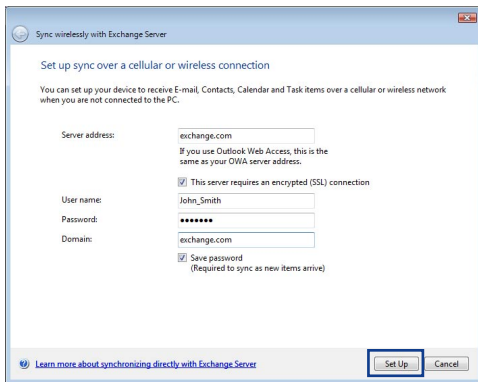

- On Windows Mobile Device Center's Home screen, click **Change content sync settings**.
- Select the check box of items you want to synchronize with the Exchange Server. Click **Sync Settings** to choose synchronization settings for the selected items. Click **Save**.



### On a Windows XP PC

1. Install Microsoft ActiveSync on your PC if you have not yet done so. See “Install ActiveSync” in Chapter 3 for details.
2. Connect your phone to the PC.
3. If you have not set up synchronization with your PC before, follow the steps in “Set up synchronization in ActiveSync” in Chapter 3 and make sure to select the **Synchronize directly with a server running Microsoft Exchange** option in the Synchronization Setup Wizard.
4. If you have synchronized your phone with your PC before, do the following steps to set up synchronization with the Exchange Server:
  - a. Right-click the ActiveSync icon (  ) at the bottom right side of your PC, then click **Open Microsoft ActiveSync**.
  - b. In ActiveSync on your PC, click **Tools > Add Server Source** then enter your company’s Exchange Server address, your username, password, and domain, then click **OK**.

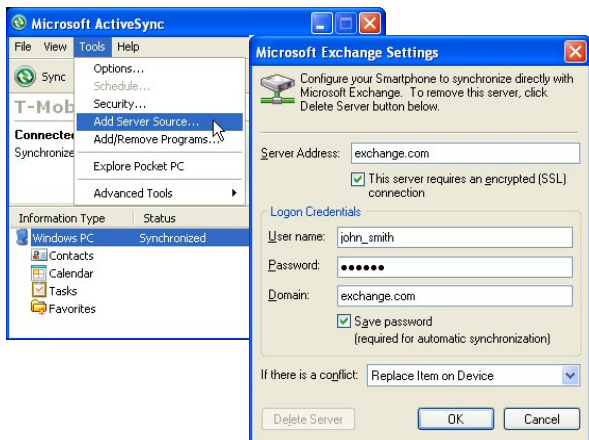



- c. Choose the items to be synchronized and other settings in the **Options, Schedule and Security** tabs, then click **OK**.

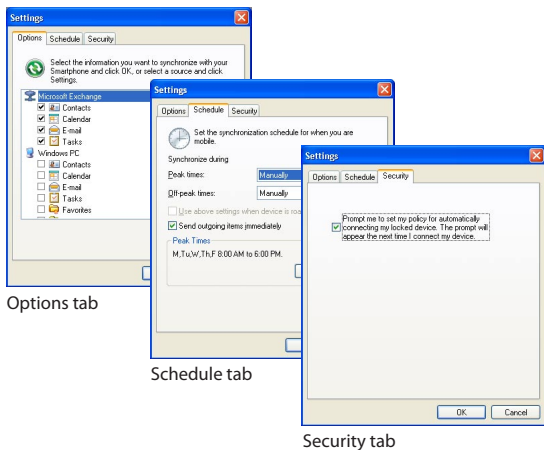

## Start synchronization

Before you start synchronizing with the Exchange Server, make sure your phone has been set up with a data connection to the Internet so that you can synchronize wirelessly. For more information about connecting to the Internet, see Chapter 8.

After you finish setting up an Exchange Server connection, your phone automatically starts synchronization.

You can manually start synchronization anytime by selecting **Sync** in ActiveSync.

### Notes

- You need a T-Mobile data plan to be able to synchronize with the Exchange Server.
- If you connect your phone to your office computer via a USB or Bluetooth connection, you can use this connection to the PC to “pass through” to the network and download Outlook e-mails and other information to your phone.

## 7.2 Working with Company E-mails

Your phone gives you instant access to your company e-mails and lets you manage your messages easier. Messaging features such as Direct Push, Fetch Mail, and Filtering messages are just some of the tools you can use to manage your e-mails.

**Note** Some messaging features depend on the Microsoft Exchange Server version used. Please check with your network administrator for the availability of Exchange Server features.



### Automatic synchronization through Direct Push

Direct Push technology (push e-mail feature) enables you to receive new e-mails on your phone as soon as they arrive in your Inbox on the Exchange Server. With this feature, items such as contacts, calendar and tasks are also immediately updated onto your phone when these items have been changed or new entries have been added on the Exchange Server. To make Direct Push work, you need to have a GPRS connection on your phone.

You need to perform a full synchronization between your phone and the Exchange Server first before Direct Push can be enabled.

**Requirement** The Direct Push feature works for your phone only if your company is using **Microsoft Exchange Server 2003 Service Pack 2 (SP2) with Exchange ActiveSync or higher version** or an equivalent push e-mail solution.

### To enable Direct Push via Comm Manager

1. On the Home screen, scroll down to  on the Shortcuts Bar, then select **Manage Connections**.
2. On the Comm Manager screen, select the **Microsoft Direct Push** button. The button  will turn to , which indicates that you will receive e-mails as they arrive.

When the button is in the  state, you need to manually retrieve your e-mails.

## To enable Direct Push via ActiveSync

1. In ActiveSync on your phone, select **Menu > Schedule**.
2. Select **As items arrive** in the **Peak times** and **Off-peak times** boxes.

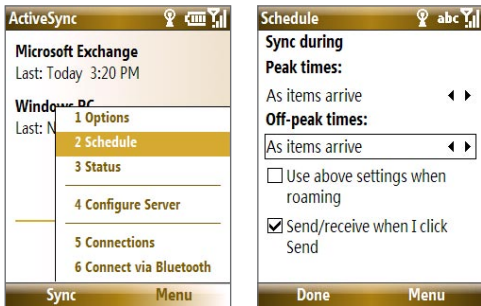

**Note** When both the GPRS/EDGE and Wi-Fi connections are turned on at the same time, the Direct Push feature will always opt for GPRS/EDGE, for which you could be charged per your T-Mobile's service plan.

## Scheduled synchronization

If you do not want to use Direct Push, you can set a regular schedule for synchronizing Outlook e-mail and information.

1. In ActiveSync on your phone, select **Menu > Schedule**.
2. Select a shorter time interval in the **Peak times** box for you to be able to receive e-mails more frequently.
3. Select a longer interval in the **Off-peak times** box.

**Tip** Select **Menu > Peak Times** to set the peak and off-peak times.

## Instant download through Fetch Mail

Fetch Mail downloads an entire e-mail immediately without the need for you to perform a full Send/Receive action.

**Requirement** Fetch Mail works for your phone only if your company is using **Microsoft Exchange Server 2007 or higher**.

1. Select **Start > Messaging > Outlook E-mail**.
2. Select an e-mail message to open it.
3. By default, only the first few kilobytes of the message is shown. To download the whole e-mail, scroll to the bottom of the message then select **Get the rest of this message**.
4. A "Downloading message" status appears. Wait for the remainder of the message body to be downloaded.

**Tip** For information about changing e-mail sync options such as the initial download size limit for e-mail, see "Customize e-mail settings" in Chapter 6.

## Search for e-mails on the Exchange Server

You can access messages that are not available on your phone by searching your Microsoft Exchange Server mailbox. The search results will be downloaded and displayed in a Search Results folder.

**Requirement** Your company must be using **Microsoft Exchange Server 2007 or higher**.

1. Select **Start > Messaging > Outlook E-mail**.
2. Select **Menu > Tools > Search Server**.
3. In the **Look for** text box, enter the search keyword.
4. Choose the **Date range** of messages to search from and where to search in **Look in**.
5. Select **Search**.

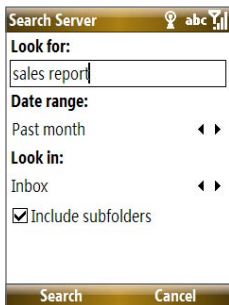

## Flag your messages

Flags serve as a reminder to yourself to follow-up on important issues or requests that are indicated in the messages.

**Requirement** Flags are enabled only if e-mails are synchronized with **Microsoft Exchange Server 2007 or higher**. Flags are disabled or hidden if e-mails are synchronized with earlier versions of Microsoft Exchange Server.

### To flag or unflag a message

1. Select **Start > Messaging > Outlook E-mail**.
2. Select a message, or open a message.
3. Select **Menu > Follow Up** and select one of the following options:
  - **Set Flag** Mark the message with a red flag to indicate that it needs follow up.
  - **Complete Flag** Mark the message with a check mark to indicate that the issue or request in the e-mail is already completed.
  - **Clear Flag** Remove the flag to unmark the message.

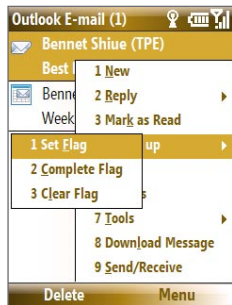

**Note** E-mail message reminders are displayed on your phone if the messages are flagged with reminders and synchronized from the Exchange Server

## Out-of-office auto-reply

Outlook Mobile allows you to retrieve and change your out-of-office status. Just like desktop Outlook E-mail, Outlook Mobile automatically sends an auto-reply message when you're not available.

**Requirement** Your company must be using **Microsoft Exchange Server 2007 or higher**.

### To send out-of-office auto-reply messages

1. Select **Start > Messaging > Outlook E-mail**.
2. Select **Menu > Tools > Out of Office**.
3. From the **I am currently** list, select **Out of the Office**.
4. Enter your auto-reply message then select **Done**.

### View a document linked to an e-mail message

When you receive an e-mail that contains a link to a document such as a PDF or Microsoft® Office document located on SharePoint or an internal file server, you can view the document on your phone.

**Requirement** You can view the document only if you have a Microsoft Outlook account that synchronizes with **Microsoft Exchange Server 2007 or later**. Exchange Server must also be set up to allow access to SharePoint document libraries or internal file servers.

1. On the Home screen, select **Start > Messaging**.
2. Select an e-mail account, then open a message with a link to a SharePoint document.
3. Select the link to open and view the document.

## 7.3 Managing Meeting Requests

When you schedule and send meeting requests from your phone, you can invite attendees to your meeting and check their status to know their availability.

When you receive a meeting request, you can reply by accepting or declining the request. The meeting request also clearly indicates whether or not there are conflicting or adjacent meetings.

**Note** You can still accept meeting requests on your phone if your company is using an earlier version of Microsoft Exchange Server, but some features will not be enabled. To use the features mentioned in this section, your company must be using **Microsoft Exchange Server 2007 or higher**.

## To reply to a meeting request

1. When there's an incoming e-mail with a meeting request, a notification message will be displayed on your phone's Home screen. Scroll to **Outlook e-mail** and select it.
2. In the Outlook message list, select the e-mail to open it.
3. Select **Accept** to reply and accept the meeting request, or select **Menu > Decline** if you cannot attend the meeting.

### Tips

- Before responding, you can check your availability during the time of the requested meeting by selecting **View your calendar**.
  - If the time of the meeting conflicts with your other appointments, a "Scheduling Conflict" status appears on top of the e-mail.
3. Choose whether or not to edit the response e-mail before sending and then select **OK**:

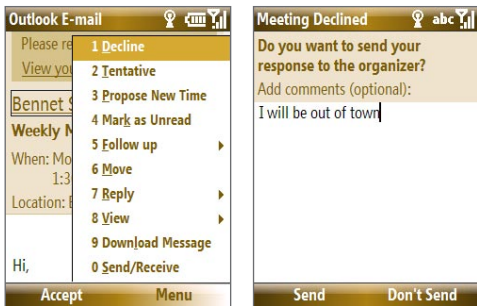

4. If you accepted the meeting request, it will automatically be added as an appointment in Calendar on your phone.

## To view the list of meeting participants

1. Select **Start > Calendar**.
2. Open a meeting request that you previously sent, then select **Attendees**. The list of required and optional attendees will be listed.

### Notes

- For information about creating a meeting request, see “To send a meeting request” in Chapter 5.
- If you select a meeting that you have organized, the list shows who has accepted or declined the meeting.
- To view an attendee’s contact information, select the attendee’s name. If the attendee is included in your contacts list, you will see the contact information immediately. If the attendee is not in your contacts list, select **Company Directory** to view the contact information.

## 7.4 Finding Contacts in the Company Directory

In addition to having contacts on your phone, you can access contact information from your organization’s Company Directory.

**Requirement** Access to the Company Directory is available only if your organization is running **Microsoft Exchange Server 2003 SP2 or higher**, and you have completed your first synchronization with the Exchange Server.

1. Synchronize with Exchange Server if you have never done so.
2. Do any of the following:
  - In Contacts, select **Menu > Company Directory**.
  - In a new e-mail, select the **To** box and then select **Company Directory** at the top of the list or select **Menu > Company Directory**.
  - In a new meeting request using Calendar, scroll to **Attendees** and select **No attendees > Add Required Attendee** or **Add Optional Attendee** and then select **Company Directory** at the top of the list.

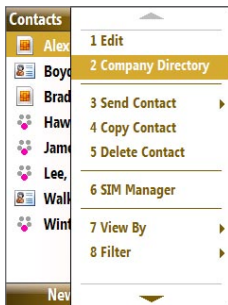

In Contacts



3. Enter the part or full contact name and select **Search**. In the search results list, select a contact to select it.

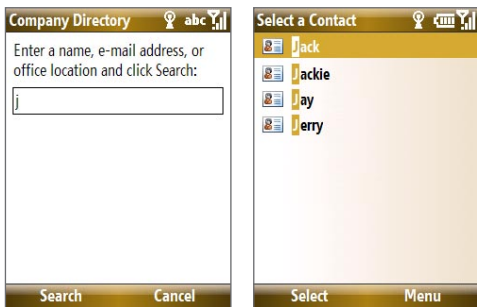

#### Notes

- You can save the contact from the Company Directory to your phone by selecting the contact then selecting **Menu > Save to Contacts**.
- You can search on the following information as long as that information is included in your organization's Company Directory: First name, Last name, E-mail name, Display name, E-mail address, or Office location.

## 7.5 E-mail Security

Windows Mobile® on your phone protects your Outlook e-mails through Secure/Multipurpose Internet Mail Extension (S/MIME), which allows you to digitally sign and encrypt your messages.

**Requirement** S/MIME encryption and digital signatures for Windows Mobile® powered smartphones are available only with **Exchange Server 2003 SP2 or a later version** that supports S/MIME. If you are not using one of these products, or have not yet synchronized, these options are unavailable.

**Note** You can encrypt a message with or without a certificate. However, to read an encrypted message, you need a valid certificate to decrypt it.

## Encrypt and sign messages

### To individually sign and encrypt a new message

1. Select **Start > Messaging > Outlook E-mail**.
2. Select **Menu > New** to create a new message.
3. Select **Menu > Message Options**.
4. From the **Security** list, select whether to encrypt only, sign the message only, or do both.
5. Select **Done**.

### To verify the digital signature on a signed message you receive

1. Open the Outlook e-mail message that has been digitally signed.
2. At the top of the message, select **View signature status**.

**Note** You may need to download the rest of the message in order for you to see the name of the person who signed the e-mail.

3. Select **Menu > Check Certificate**.

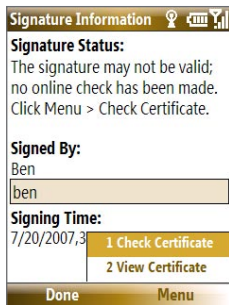
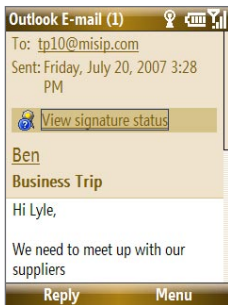

To view the details of the certificate in the message, select **Menu > View Certificate**.

**Note** There can be several reasons why a digital signature is not valid. For example, the sender's certificate may have expired, it may have been revoked by the certificate authority, or the server that verifies the certificate is unavailable. Contact the sender to report the problem.

## To digitally sign and encrypt all messages

You can set up ActiveSync to digitally sign and encrypt all outgoing messages. You must obtain a valid certificate to sign and encrypt e-mail messages successfully.

1. Select **Start > ActiveSync**.
2. Select **Menu > Options**.
3. Select the **E-mail** information type, and select **Settings**. On the E-mail Sync Options screen, select **Menu > Advanced**.

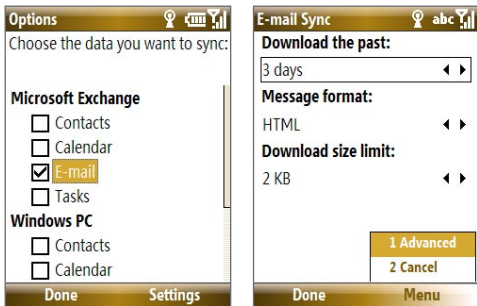

4. Select **Encrypt messages** to protect your e-mails from being viewed except by the intended recipients. Select **Sign messages** so that recipients are certain that e-mails are sent by you and have not been altered.
5. Select **Menu > Choose Certificate** to select a certificate for signing or encrypting outgoing e-mail messages.

## Set permissions on an e-mail message

Another way of protecting your e-mail messages is to send messages with restricted permissions using Information Rights Management (IRM).

**Requirement** This works only with a Microsoft Outlook e-mail account and if your company is using RMS Server SP1.

1. Select **Start > Messaging > Outlook E-mail**.
2. Create a message, then select **Menu > Message Options**.

**3.** In **Permissions**, do one of the following:

- To allow anyone to read the message, select **Unrestricted Access**.
- To prevent the message from being forwarded, printed, or copied, select **Do Not Forward**.

**4.** Select **Done**.

**Tip** An IRM-protected message received on your phone can only be replied to or forwarded if the message permits it.

# Chapter 8

## Getting Connected

**8.1 Comm Manager**

**8.2 Ways of Connecting to the Internet**

**8.3 Wi-Fi**

**8.4 GPRS/EDGE**

**8.5 Dial-up and Others**

**8.6 Internet Explorer® Mobile**

**8.7 Using Your Phone as a Modem  
(Internet Sharing)**

**8.8 Bluetooth**

**8.9 Windows Live™**

**8.10 Windows Live Messenger**

**8.11 Windows Live™ Search**

## 8.1 Comm Manager

Comm Manager acts like a central switch that lets you enable or disable phone features as well as manage your data connections easily.

### To open Comm Manager:

On the Home screen, scroll down to  on the Shortcuts Bar, then select **Manage Connections**.



- 1 Select to enable or disable the phone. Select **Settings > Phone** to access phone settings.
- 2 Select to toggle between turning on or off Bluetooth. See “Bluetooth” for details. Select **Settings > Bluetooth** to configure Bluetooth on your phone.
- 3 Select to toggle between turning on or off Wi-Fi. Select **Settings > Wi-Fi** to configure Wi-Fi on your phone. See “Wi-Fi” for details.
- 4 Select to toggle between automatically receiving (as items arrive) or manually retrieving Outlook e-mails. See Chapter 7 for details. Disabling this feature will override the options you have set for your synchronization schedule.
- 5 Select to disconnect active data connections (e.g. GPRS/EDGE). You cannot reconnect a data connection in Comm Manager.
- 6 Select to turn on the phone's ringer or set it to vibration/mute mode.
- 7 Select to open ActiveSync so you can synchronize the phone and computer. For more information regarding ActiveSync, see Chapter 3.
- 8 Select to toggle between allowing or not allowing the phone to receive incoming Bluetooth beams from other devices.

## 8.2 Ways of Connecting to the Internet

Your phone's networking capabilities allow you to access the Internet or your corporate network at work through wireless and conventional connections.

You can connect to the Internet by using one of the following:

- Wi-Fi
- GPRS or EDGE
- Dial-up

**Note** You can also add and set up the following connections:

- **VPN:** A VPN connection is used to access your corporate network by using an existing Internet connection.
- **Proxy:** A Proxy connection is used to access the Internet using an existing connection to your corporate or WAP network.

## 8.3 Wi-Fi

Wi-Fi provides wireless Internet access over distances of up to 300 feet. To use Wi-Fi on your device, you need access to a wireless access point or "hotspot".

**Note** The availability and range of your phone's Wi-Fi signal depends on the number, infrastructure, and other objects through which the signal passes.

### Connect to T-Mobile HotSpot

T-Mobile HotSpot gives you wireless access to the Internet over the T-Mobile Wi-Fi network in convenient locations across the U.S., such as airports, coffee shops, bookstores, universities, and more. It is great for e-mail, Web browsing, and other high-bandwidth applications. Contact T-Mobile to add T-Mobile HotSpot service to your data plan.



Your device can automatically log you into T-Mobile's wireless network whenever you visit a T-Mobile HotSpot.

### To log in to T-Mobile HotSpot

1. Select **Start > T-Mobile HotSpot > HotSpot Settings**.
2. Type in your T-Mobile HotSpot **Username** and **Password** and select **OK**.

Simply turn on Wi-Fi from Comm Manager when you are in a T-Mobile HotSpot, and you will be connected.

When logging into a T-Mobile HotSpot with Wi-Fi turned on, you will see  (this means it is trying to connect) on top of the Home screen. Once you successfully log in to the T-Mobile HotSpot, you will see a confirmation screen.

The  icon on the Home screen changes to  when you are successfully logged in.

### To log off from T-Mobile HotSpot

1. Select **Start > T-Mobile HotSpot > HotSpot Status**.
2. Select **Logoff**.

**Note** If you have attempted to login and see  on the Home screen, there has been an error in your login. Select **Start > T-Mobile HotSpot > HotSpot Status** to display the status of your login attempt.

### To change the HotSpot Utility settings

The HotSpot Utility will automate your login process when you are in a T-Mobile HotSpot.

1. Select **Start > T-Mobile HotSpot > HotSpot Settings**.
2. Select **Menu > Advanced Settings**.
3. Select or clear the options you want.



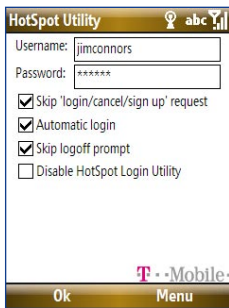

- **Skip 'login/cancel/sign up' request:** If not selected, the HotSpot Found screen will be displayed first for you to log in (if Username and Password are not correctly filled in). If you want to get a T-Mobile HotSpot account, select **Sign up for T-Mobile HotSpot service**.
- **Automatic login:** If not selected, you will be prompted to type in your username and password whenever you turn on Wi-Fi and try to connect to T-Mobile HotSpot.
- **Automatic logoff:** If not selected, a message will always display first to confirm whether you want to log off from the T-Mobile HotSpot service.
- **Disable HotSpot Login Utility:** If selected, you will not be prompted to connect when you are in a T-Mobile HotSpot location. To connect, clear this check box.

4. Select **OK**.

#### To reset HotSpot Utility settings

1. Select **Start > T-Mobile HotSpot > HotSpot Settings**.
2. Select **Menu > Reset All**.

**Note** The Username and Password fields will also be cleared.



### To find a T-Mobile HotSpot location

1. Connect to the Internet using Wi-Fi, GRPS/EDGE, or dial-up.
2. On the Home screen, scroll down to  on the Shortcuts Bar, then select **Browse Web**.
3. Select **Menu > Favorites > HotSpot locator** and select **Go**.

**Note** You may need to press one of the SOFT KEYS to show **Menu**.



4. Enter or type in the search criteria and select **Submit** on the page.

locator.t-mobile.com/pd.   

Find a T-Mobile HotSpot

Use our store locator to find a T-Mobile location that's convenient for you.

Select a location type:  
T-Mobile HotSpot locator ▶

Country  
United States ▶

Street Address or Landmark\*

Favorites Menu

washington

Postal code  
98004

Search radius  
5 miles ▶

\* Note: To search by landmark, please clear all other address-related fields.

Powered by Microsoft MapPoint Technology and [SpatialPoint](#):  
[Terms of Use](#) | [Privacy Statement](#)

United States ▶

Street Address or Landmark\*  
eastgate

City  
bellevue

State or province  
washington

Postal code  
98004

Search radius  
5 miles ▶

## Connect to other wireless networks

### To create a connection to an existing Wi-Fi network

1. On the Home screen, scroll down to  on the Shortcuts Bar, then select **Manage Connections**.
2. On the Comm Manager screen, select the **Wi-Fi** icon. The Wi-Fi icon is then highlighted to indicate that Wi-Fi is turned on.
3. After a few seconds, a message asks you if you want to see the list of available networks, select **Yes**.
4. In **Select network**, press NAVIGATION left or right to choose the Wi-Fi network to connect to.
5. In **Network type**, select **Internet** and select **Connect**.  
If you are connecting to a security-enabled network, you will be asked to enter the **Network Key** (WEP, WPA-PSK, WPA2, etc.) Enter the Network **Key** and select **Done**.

You can check the Wi-Fi icon the Title bar on the screen to see if you are connected to the Wi-Fi network. To see the status icons, please see “Status Indicators” in Chapter 1.

### Notes

- Wi-Fi connects to the default network that is available on your phone. However, GPRS/EDGE starts by default if your phone does not detect any Wi-Fi signal.
- In Comm Manager, select **Settings > Wi-Fi > Connection Status** to check the current connection status and signal quality of each Wi-Fi channel.
- Configure your phone so that the Wi-Fi function turns off automatically when no signal is detected to conserve battery power. In Comm Manager, select **Settings > Wi-Fi > Wi-Fi Networks > Menu > Wi-Fi Settings**.

### To create a new Wi-Fi connection

If the Wi-Fi connection you want to connect to is not in the list, you can create a new Wi-Fi connection.

1. On the Home screen, select **Start > Settings > Connections > Wi-Fi Settings > Wi-Fi Networks > New**.
2. Enter the **Network name** and **Network type** and select **Next**.

**Note** If you want only to connect directly to another device or computer, and not to a network through an access point, select **This is a device to device (ad-hoc) connection**.

3. Select the **Authentication** type and **Data encryption**, then select **Next**.

Default settings are:

**Authentication** = Open ; **Data Encryption** = WEP

For TKIP, AES, or WEP data encryption, enter the needed information in the remaining fields, then select **Next**.

4. Select **Use IEEE 802.1x network access control** to use Extensible Authentication Protocol (EAP). Select the **EAP type** depending on the type of authentication. Select **Finish**.

### To increase security on the Wi-Fi network

The LEAP (Lightweight Extensible Authentication Protocol) feature of Comm Manager helps increase security on your phone, and ensures that nobody is able to access your network without your permission.

1. On the Wi-Fi Settings screen, select **LEAP**.
2. Select **Menu > New**.

**Note** By default, the LEAP screen displays data that you entered previously. However, you can modify or delete the data as required by selecting **Menu > Modify** or **Menu > Delete** on the LEAP screen.
3. Enter the **SSID** (Service Set Identifier).  
You can obtain this information from T-Mobile.
4. Enter the user name, password, and domain.
5. Select an **Authentication Type**. By default, the **Authentication Type** for your phone is **Open System** authentication.

**Note** For LEAP to work correctly, the receiving phone (your phone) must be set with the same SSID, user name, and password as the access point.

## 8.4 GPRS/EDGE

You can use GPRS/EDGE to connect to the Internet or to send and receive Picture Messages on your phone. You need a data plan to access the T-Mobile GPRS/EDGE network.

**Note** T-Mobile GPRS/EDGE settings are already preconfigured and modifying them may cause services to stop working.

### To set up a new GPRS/EDGE connection

If GPRS/EDGE settings are not preset on your phone or are accidentally deleted, obtain the **Access point name** from T-Mobile. Also, check with T-Mobile if a user name and password are required.

1. On the Home screen, select **Start > Settings > Connections > GPRS > New**.
2. In **Description**, enter a name for the connection.
3. In **Connects to**, select **The Internet**.
4. Enter the name of the **Access point** of T-Mobile.
5. Enter the appropriate information in the remaining fields, if required by T-Mobile and select **Done**.

The screenshot shows the 'Add GPRS' configuration screen. The title bar is gold and contains the text 'Add GPRS' and a signal strength icon. Below the title bar, there are several labeled fields: 'Description:' with the value 'GPRS'; 'Connects to:' with a dropdown menu showing 'The Internet'; 'Access point:' with a text input field containing 'accesspoint'; 'User name:' with an empty text input field; and 'Password:' with an empty text input field. At the bottom of the screen, there are two gold buttons: 'Done' and 'Cancel'.

## 8.5 Dial-up and Others

When you use your phone to dial up to your ISP and connect to the Internet or to your corporate network, you will be billed by the number of minutes that you use.

### To set up a dial-up connection for browsing the Internet

1. On the Home screen, select **Start > Settings > Connections > Dial-up > Add**.
2. In **Description**, enter a name for the connection.

3. In **Connects to**, select **The Internet**.
4. Enter the appropriate information in the remaining fields.
5. Select **Done**.

### To set up a dial-up connection to your corporate network

1. On the Home screen, select **Start > Settings > Connections > Dial-up > Add**.
2. In **Description**, enter a name for the connection.
3. In **Connects to**, select **Work**.
4. Enter the appropriate information in the remaining fields.
5. Select **Done**.

### To add a URL exception

Some URLs for Web pages on your company intranet may use periods, for example: intranet.companyname.com. To view these pages in Internet Explorer® Mobile, you must create a URL exception.

1. On the Home screen, select **Start > Settings > Connections > Menu > Advanced**.
2. Select **Menu > Work URL Exceptions > Menu > Add**.
3. In **URL Pattern**, enter the URL name. To add multiple URLs, use a semicolon (;).
4. Select **Done**.

**Note** You do not need to create URL exceptions for Internet URLs.

### Advanced options

From the Connections screen, you can access advanced options to specify the service provider, the number of redial attempts, the amount of idle time to wait before disconnecting, and so on.

1. On the Home screen, select **Start > Settings > Connections > Menu > Advanced**.
2. Select a network service provider for each connection type. You can choose **Automatic** to allow the phone to set a service provider for each connection by default.
3. Select **Menu > Options**.

- Choose the appropriate information in the remaining fields.
- Select **Done**.

## 8.6 Internet Explorer® Mobile

Internet Explorer® Mobile is a full-featured Internet browser, optimized for use on your phone.

### To open Internet Explorer Mobile

On the Home screen, scroll down to  on the Shortcuts Bar, then select **Browse Web**.

### Browse the Web

- In Internet Explorer® Mobile, do one of the following:
  - In the Search bar, enter the keyword to use for searching information on the Web, then select .
  - Select **Menu > Address Bar**, enter the Web page address and then select **Go**.

**Note** You may need to press one of the SOFT KEYS to show **Menu**.

- Use the **NAVIGATION WHEEL** to browse the Web page. Press **CENTER SELECT** when a link is highlighted to access it.

While browsing the Web, select **Menu** to open a list of options that will let you change the view, save Favorites, and set Internet Explorer® Mobile preferences, and more.

**Note** You may need to press one of the SOFT KEYS to show **Menu**.

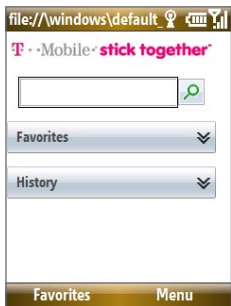

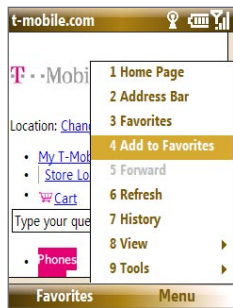

Select **Menu > Add to Favorites** to save the current Web page in your Favorites folder. Select **Favorites** to access your Favorites folder.



Select **Menu > View** and then select the text size and type of view you want to use while browsing a Web page.

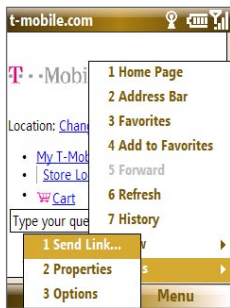

Select **Menu > Tools** to let you send the link to let you send the link via e-mail, view the page's properties, or set Internet Explorer® Mobile preferences.

For more information about Internet Explorer® Mobile, please go to:  
<http://www.microsoft.com/windowsmobile/help/smartphone/browseinternet.mspx>



## 8.7 Using Your Phone as a Modem (Internet Sharing)

With **Internet Sharing**, you can use your phone as an external modem for another device such as a PDA or notebook computer.

### Notes

- Make sure your phone has a SIM card installed, and your phone has a GPRS/EDGE or phone dial-up modem connection. If your phone has not been set up with a data connection yet, select **Menu > Connection Settings** on the Internet Sharing screen. For more information about setting up a GPRS/EDGE connection, see "GPRS/EDGE". For more information about setting up a phone dial-up connection, see "Dial-up and Others".
- Before using Internet Sharing, disconnect your phone from Windows Mobile Device Center or ActiveSync. In Windows Mobile Device Center, mouse over **Mobile Device Settings**, click **Connection settings**, then clear the **Allow USB connections** check box. In ActiveSync on your PC, click **File > Connection Settings** then clear **Allow USB connections**.

### To set up the phone as a USB modem

1. On your phone, select **Start > Accessories > Internet Sharing**.
2. In the **PC Connection** list, select **USB**.
3. In the **Network Connection** list, select the name of connection that your phone uses to connect to the Internet.
4. Plug in the USB cable between your phone and the computer.
5. Select **Connect**.

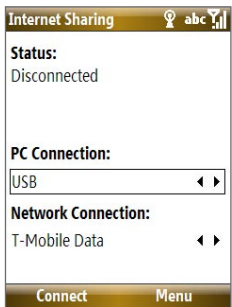

### To set up the phone as a Bluetooth modem

1. On your phone, turn on Bluetooth and set it to **Visible** mode by following the steps in “To turn on or off Bluetooth on your phone.”
2. Initiate a Bluetooth partnership from your phone by following the steps in “To create a Bluetooth partnership.”
3. Select **Start > Accessories > Internet Sharing**.
4. Select **Bluetooth PAN** as the **PC Connection**.
5. From the **Network Connection** list, select the name of the connection that your phone uses to connect to the Internet.
6. Select **Connect**.
7. On your computer, set up a Bluetooth Personal Area Network (PAN) with your phone:

#### For Windows Vista:

- a. Click **Start > Control Panel > Network and Sharing Center**.
- b. Click **Manage network connections** and then under **Personal Area Network**, double-click **Bluetooth Network Connection**.
- c. In the Bluetooth Personal Area Network Devices dialog box, select your phone, then click **Connect**.

#### For Windows XP:

- a. Click **Start > Control Panel > Network Connections**.
- b. Under **Personal Area Network**, click the **Bluetooth Network Connection** icon.
- c. Under **Network Tasks**, click **View Bluetooth network devices**.
- d. In the Bluetooth Personal Area Network Devices dialog box, select your phone, then click **Connect**.
8. On the Internet Sharing screen on your phone, check if a connected status is displayed, which indicates that your computer has been successfully connected to the Internet using your phone as a Bluetooth modem.

### To end the Internet connection

On the Internet Sharing screen, select **Disconnect**.

## 8.8 Bluetooth

Bluetooth is a short-range wireless communications technology. Phones with Bluetooth capabilities can exchange information within a distance of about 30 feet without requiring a physical connection.

### Bluetooth modes

Bluetooth on your phone operates in three different modes:

- 1. On.** Bluetooth is turned on. Your phone can detect other Bluetooth-enabled devices, but not vice versa.
- 2. Off.** Bluetooth is turned off. In this mode, you can neither send nor receive information using Bluetooth.
- 3. Visible.** Bluetooth is turned on, and all other Bluetooth-enabled devices within range can detect your phone.

**Note** By default, Bluetooth is turned off. If you turn it on, and then turn off your phone, Bluetooth also turns off. When you turn on your phone again, Bluetooth automatically turns on.

### To turn on or off Bluetooth on your phone

You can enable Bluetooth by selecting the Bluetooth button in the Comm Manager. You can also do the following:

1. On the Home screen, select **Start > Settings > Connections > Bluetooth**.
2. Select **Bluetooth > Menu > Turn On Bluetooth**.

To turn off Bluetooth capabilities on your phone, select **Bluetooth > Menu > Turn Off Bluetooth**.

### To make your phone visible

1. On the Home screen, select **Start > Settings > Connections > Bluetooth**.
2. Select **Bluetooth > Menu > Turn On Visibility**.

**Tip** Enter a Bluetooth phone name for your phone. This will be the phone name that will be shown on another Bluetooth-enabled device when it searches and detects your phone. To enter a name, on the Bluetooth screen, select **Security** and enter a **Device name**.

## Bluetooth partnerships

A Bluetooth partnership is a relationship that you create between your phone and another Bluetooth-enabled device in order to exchange information in a secure manner.

### To create a Bluetooth partnership

1. On the Home screen, select **Start** > **Settings** > **Connections** > **Bluetooth**.
2. Select **Bluetooth** > **Add new device**.  
Your phone searches for other Bluetooth-enabled devices and lists them.
3. Select the desired device name in the list and select **Next**.
4. Enter a passcode (1 up to 16 characters) to establish a secure connection, then select **Next**.
5. Wait for the paired device to accept the partnership:
6. On your phone, a message will appear, indicating that your phone has connected with the paired device. Select **OK**.
7. The name of the paired device is then displayed. You may edit and enter a new name for that device, then select **Next**.
8. Select the check boxes of services that you want to use from the paired device and select **Done**.

### To accept a Bluetooth partnership

1. Ensure that Bluetooth is turned on and in visible mode.
2. Select **Yes** when prompted to establish a partnership with the other device.
3. Enter a passcode (the same passcode that is entered on the device requesting the partnership) to establish a secure connection.
4. Select **Next**.
5. A message will appear, indicating that your phone has connected with the paired device. Select **OK**.
6. The name of the paired device is then displayed. You may edit and enter a new name for that device, then select **Next**.

7. Select the check boxes of services that you want to use from the paired device.
8. Select **Done**. You can now exchange information with the other device.

### To change the display name of a Bluetooth device

1. On the Home screen, select **Start** > **Settings** > **Connections** > **Bluetooth**.
2. Select **Bluetooth** and then on the screen, select a Bluetooth device.
3. Select **Menu** > **Edit**.
4. Enter a new display name for the Bluetooth device, then select **Next**.
5. Select **Done**.

### To delete a Bluetooth partnership

1. On the Home screen, select **Start** > **Settings** > **Connections** > **Bluetooth**.
2. Select **Bluetooth** and then on the screen, select a Bluetooth device.
3. Select **Menu** > **Delete**, and then select **Yes** in the confirmation screen.
4. Select **Done**.

### Connect a Bluetooth hands-free or stereo headset

For hands-free phone conversations or to listen to music, you can use a Bluetooth hands-free or stereo headset.

**Note** To listen to music using a wireless headset, you need to use a Bluetooth stereo headset.

### To connect a Bluetooth hands-free or stereo headset

1. Make sure that both your phone and the Bluetooth headset are turned on and within close range, and that the headset is visible. Refer to the manufacturer's documentation to find out how to set the headset in visible mode.
2. On the Home screen, select **Start** > **Settings** > **Connections** > **Bluetooth**.

3. Select **Bluetooth > Add new device**. Your phone searches for other Bluetooth-enabled devices and displays them in the list.
4. Select the name of the headset, and select **Next**.
5. In **Passcode**, enter the alphanumeric passcode for the Bluetooth headset, then select **Next**. The passcode is usually "0000" or "1234". If these do not work, then refer to headset documentation for the code.

A message will appear saying that your phone has connected to the headset, select **OK**.

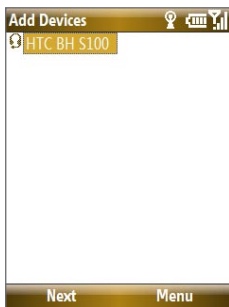

6. Enter the display name for the headset and select **Next**.
7. Select the check boxes for the **Wireless Stereo** (if available) and **Hands Free** services, and select **Done**.

**Note** If the Bluetooth stereo headset becomes disconnected, turn the headset on and repeat steps 1 to 2 above. Select the stereo headset and select **Menu > Set as Wireless Stereo**.



## Beam information using Bluetooth

You can beam information, such as contacts, calendar items, and tasks, as well as files from your phone to your computer or to another Bluetooth-enabled device.

### Notes

- If your computer does not have built-in Bluetooth capabilities, you need to connect and use a Bluetooth adapter or dongle on your computer.
- Before beaming items to your computer, open Bluetooth Configuration or Bluetooth Settings in the Control Panel and check if there's an option for setting a location for saving beamed items.

### To beam information from your phone to a computer

1. Set Bluetooth on your phone to visible mode. For information about this, see “To make your phone visible”.
2. Next, set Bluetooth on your computer to visible mode, create a Bluetooth partnership, then enable your computer to receive Bluetooth beams.

If your computer has Windows Vista or Windows XP SP2 and your computer's Bluetooth adapter is supported by your Windows version, do the following steps:

- a. On your computer, open **Bluetooth Devices** from the Control Panel then click the **Options** tab.
- b. For **Windows Vista**, select **Allow Bluetooth devices to find this computer**.  
For **Windows XP**, select **Turn discovery on** and **Allow Bluetooth devices to connect to this computer**.
- c. Create a Bluetooth partnership between your phone and computer. For information about creating a partnership, see “Bluetooth partnerships”.
- d. In the **Options** tab of **Bluetooth Devices**, select **Show the Bluetooth icon in the notification area**.
- e. To enable your computer to receive Bluetooth beams, right-click the Bluetooth icon at the bottom-right of your computer screen and select **Receive a File**.

3. Now you are ready to beam. On your phone, select an item to beam. The item can be an appointment in your calendar, a task, a contact card, or a file.
4. Select **Menu > Beam [type of item]**.
5. Select the device name to which you want to beam to.
6. Select **Beam**.
7. If you beamed a calendar, task, or contact item to your computer and it is not automatically added to Outlook, select **File > Import and Export** to import it to Microsoft Outlook on your computer.

To beam information to a Bluetooth-enabled device such as another phone, create a Bluetooth partnership then do steps 3 to 6 in the above procedure.

**Tip** The default folder on your computer where beamed items are stored may be  
**Windows XP:** C:\Documents and Settings\your\_username\My Documents  
**Windows Vista:** C:\users\your\_username\My Documents.

## Print files via Bluetooth

Connect your device to a Bluetooth printer to print contact information, appointment details, messages, and other file types.

**Note** You can print files in the **.txt, .jpg, .html, .vcf, .vcs** file formats.

Before you start printing, make sure to turn on the Bluetooth printer and to turn on Bluetooth on your phone. To turn on Bluetooth, select **Start > Comm Manager** and then select the **Bluetooth** button.

### To print contact information

1. Select **Start > Contacts** and then select the contact whose information you want to print.
2. Select **Menu > Print via Bluetooth**.
3. Select **Menu > Search Devices**. Your phone starts to search for Bluetooth devices.
4. Select the Bluetooth printer and select **Menu > Send File**.
5. Set the printing options you want and then select **Print**.



### To print a calendar appointment

1. Select **Start > Calendar** and then select the appointment whose details you want to print.
2. Follow steps 2 to 5 in the “To print contact information” procedure.

### To print a message

1. Select **Start > Messaging** and then select the messaging account where the message you want to print is located.
2. Select the message you want to print.
3. Follow steps 2 to 5 in the “To print contact information” procedure.

### To print a JPEG file

1. In Pictures & Videos, select the JPEG file and then select **Menu > Print via Bluetooth**.
2. Follow steps 3 to 5 in the “To print contact information” procedure:

## 8.9 Windows Live™

Windows Live™ gives you full Internet experience on your phone. It helps you to find information, pursue your interests, and get in touch with friends and family on the Internet easier.

Windows Live offers the following key features:

- **Live Search Bar**, which lets you search for information on the Web.
- **Live Messenger**, the next generation of MSN Messenger Mobile.
- **Live Mail**, the next generation of Hotmail.
- **Live Search**, which lets you find locations, browse maps, and check for directions.
- **Live Contacts**, address book for storing Live Mail, Live Messaging, and Hotmail contacts.

### Set up Windows Live™

The first time you use Windows Live™, sign in by using your Windows Live ID, which is your Windows Live Mail or Hotmail address, and password.

### To set up Windows Live for the first time

1. On the Home screen, scroll down to  on the Shortcuts Bar, then select **Set Up E-mail**.
2. On the Select Account screen, select **Windows Live**.
3. On the Windows Live screen, select **Sign in to Windows Live**.
4. On the next screen, select the links to read the Windows Live™ Term of Use and the Microsoft Privacy Statement. After reviewing them, select **Accept**.
5. Enter your Windows Live Mail or Hotmail address and password, then select **Next** twice.
6. Choose what information you want to synchronize online with your phone.

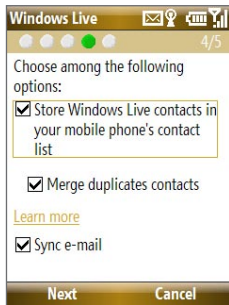

If you choose to synchronize **Store Windows Live contacts in your mobile phone's contact list**, your online contacts will be added to the contact list and to Windows Live Messenger on your phone.

If you choose **Sync E-mail**, your Windows Live Mail or Hotmail inbox messages will be downloaded to your phone.

7. Select **Next**.
8. After synchronization is complete, select **Done**.

## The Windows Live™ interface

On the main interface of Windows Live™, you will see a search bar, navigation bar, and an area where you can customize to show your picture.

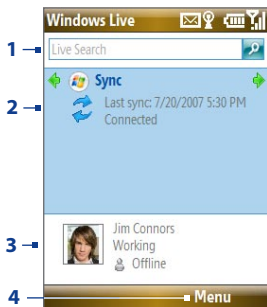

- 1 This is the Windows Live Search bar.
- 2 Press **NAVIGATION** left or right to switch among Live Mail, Messenger, and Sync status. Select to open/activate the selected Windows Live component.
- 3 Select to access Windows Live Messenger settings.
- 4 Select **Menu** to access and change settings.

## 8.10 Windows Live Messenger

Live Messenger lets you send and receive instant messages online. With this mobile version of Windows Live Messenger, you enjoy many of the same cool features that you get from the desktop version, which include the following:

- Instant messaging via text and voice
- Multiple conversations
- Add emoticons
- Contact list with presence
- Send and receive files including photos
- Change status/display name
- View contacts by online status, groups, and more
- Send messages even when a contact is offline

### Notes

- Before you can use Live Messenger, your phone must be connected to the Internet. For information about setting up an Internet connection, see “Ways of Connecting to the Internet” in this chapter.
- You also need to have a T-Mobile data plan to use Live Messenger.

## Launch the messenger and sign in

### To open Live Messenger

Do one of the following:

- On the Home screen, select **Start > Messenger**.
- On Windows Live of the Home screen, Press NAVIGATION left or right until you see **Messenger**, then press ENTER.

### To sign in and out

1. To sign in, select **Sign in** on the messenger screen.
2. If this is your first time to sign in, a message appears to inform you that your messenger contacts will be added to the contact list on your phone. Select **OK** to add them.  
Signing in may take several minutes, depending on your connection speed.
3. To sign out, select **Menu > Sign Out**. Your status changes to **Offline**.

## Add Windows Live™ contacts

You can add new Windows Live™ contacts in Live Messenger or in Contacts.

### To add a Windows Live contact in Live Messenger

1. Select **Menu > Add new contact**.
2. Enter the e-mail address of the contact then select **OK**.

### To add a Windows Live contact in Contacts

1. On the Home screen, select **Start > Contacts**.
2. Select **New** then select **Windows Live**.
3. In the **IM** box, enter the e-mail address of the contact, which can be a Windows Live ID or any other e-mail address.

**Tip** You can fill in other information about the contact, if desired. This is not absolutely necessary if you will communicate with the contact only through Windows Live Messenger or Live Mail.

4. Select **Done**.
5. Follow the remaining instructions to add the new contact to your Windows Live™ contact list.

### To delete a contact

1. In the messenger, select the contact and select **Menu > Contact options > Remove contact**.
2. Choose whether to block the contact.
3. Choose whether to also delete the contact from your phone's contact list.
4. Select **OK**.

### Send instant messages

You can send instant messages with emoticons, and even talk by sending a voice clip. While chatting, you can send and receive files directly on a message window. You can also start conversations with several contacts and switch between their message screens, or you can invite participants to join in a conversation.

### To start and end conversations

1. In the contact list, select a contact then select **Send IM** to open a message screen.

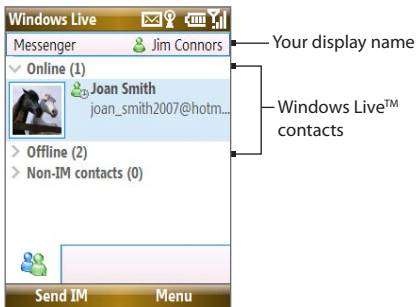

2. Send an instant message. See “To send an instant message with emoticon” for details.

- 3 To start a conversation with another contact, press left or right **NAVIGATION** to go back to the contact list, then select another contact and select **Send IM** again. Another message screen opens.
- 4 To switch from one message screen to another, press left or right **NAVIGATION** to the display picture of the contact whom you want to talk to.



Pictures of contacts whom you're talking to

- 5 To end a conversation with the current contact, select **Menu > End conversation**.
- 6 To end all active conversations, select **Menu > End all conversations**.

### To send an instant message with emoticon

1. Select a contact and start a conversation.
2. Enter your text message in the text entry area of the message screen.
3. To add an emoticon, select **Menu > Add emoticon** then select an icon from the list of emoticons.
4. Select **Send**.

### Tips

- To send a file, select **Menu > Send**. You can choose to send a picture, voice clip or any file.
- To invite one or more contacts to the conversation, select **Menu > Options > Add participant**.

### To send a voice message

1. Select a contact and start a conversation.
2. Select **Voice clip** then start talking.
3. After you have spoken a message, select **Send**.

## Personalize the messenger

While on the contacts list, you can do the following:

- Select **Menu > Change status** to set your current status (such as Busy, Out to lunch, etc.) so that your contacts will know whether or not you're available.
- Select **Menu > Change appearance** to change your display name, add a personal message, and add your picture.
- Select **Menu > Sort by** to organize contacts by online status, groups, name, or e-mail address. You can also hide offline contacts from the contact list.
- Select **Menu > Add** new contact to add a new Live Messenger contact.
- Select **Menu > Contact options** to open a menu where you can view contact properties, block the contact, remove the contact, and more.
- Select **Options** to see more settings.

## 8.11 Windows Live™ Search

Windows Live™ Search is a separate program that offers you a fast and easy way to find and view maps and local information on your phone. With Windows Live™ Search, you can:

- Browse through local listings of categories.
- Locate nearby restaurants, shopping centers, etc., and check for their street addresses and phone numbers.
- View maps with directions to and from a location.
- View traffic information.

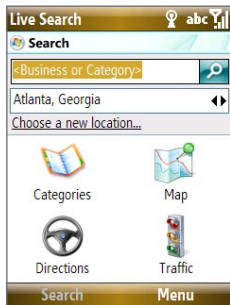

### To open Windows Live Search

Select **Start > Live Search**.

### To find a location

1. Specify first where the location is near to. You can select from the list of cities. You can also select **Choose a new location** to enter a city, select on a map, or get a contact's address.
2. Enter the location that you want to find, then select **Search**.
3. The Search Results screen then shows a list of matched places. Use the Navigation Control to browse through the list. As you browse, the address, phone number, and estimated distance of a selected item are displayed.
4. Select the desired location in the Search Results screen.
5. On the Details screen, select **Map** to see the location on a map. Select **Directions to Here** for instructions on how to reach the location.

**Note** If you connect a Bluetooth GPS receiver and set it up on your phone, Live Search can track your current position. You can use your current position as a starting point for finding a desired location.



# Chapter 9

## Experiencing Multimedia

**9.1 Camera**

**9.2 Pictures & Videos**

**9.3 Windows Media® Player Mobile**

**9.4 Java Applications**



## 9.1 Camera

Taking photos and shooting video clips are easy with your phone's built-in camera.

### To open Camera

Do any of the following:

- Press the **CAMERA** button on the right side of the phone.
- On the Home screen, select **Start > Applications > Camera**.

Opening the Camera program automatically switches the screen orientation to landscape mode.

### To exit Camera

Press .

**Note** Pressing  simply "minimizes" the Camera program, it is still running in the background. To close the Camera program, go to Task Manager.





### Take a photo or capture a video clip

Aim the camera at the subject and then press **CENTER SELECT** to take the shot. When capturing video, press **CENTER SELECT** to start recording; press it again to stop.

### Capture modes

The Camera program lets you capture pictures and video clips by using various built-in modes. The title bar displays the active capture mode.

The available capture modes are as follows:

Capture mode	Function
Photo (  )	Captures standard still images.
Video (  )	Captures video clips, with or without audio.
MMS Video (  )	Captures video clips suitable for sending via MMS.
Contacts Picture (  )	Captures a still image suitable for assigning as an identification photo to a contact.

Picture Theme (  ) Captures still images and places them within frames.

Sports (  ) Captures a sequence of still images (3 or 5 frames) automatically for a short duration at a defined frequency.

Using the above capture modes, the camera captures files in the following formats:

Capture type	Format
Still Image	JPEG
Video	Motion-JPEG AVI (.avi) MPEG-4 (.mp4) H.263 baseline (.3gp)
MMS Video	MPEG-4 (.mp4) H.263 baseline (.3gp)

### To change the capture mode

On the Camera screen, press **NAVIGATION** right until you see the capture mode icon you want to use on the upper-left part of the screen.

### Camera mode icons and indicators

The camera icons and indicators disappear from the screen after **3** seconds. Press one of the SOFT KEYS to make them reappear.

#### The Camera [Photo] screen

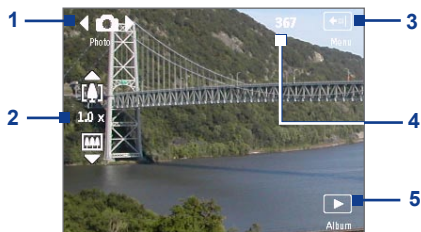

- 1 Indicates the current capture mode.
- 2 Indicates the current zoom ratio. Press **NAVIGATION** up or down (Landscape orientation) to increase or decrease the zoom level.

- 3 Select to open the Camera Settings screen.
- 4 Depending on the capture mode, this shows the remaining, available shots of pictures that you can take or remaining duration that can be recorded. While recording video, this shows the recorded duration.
- 5 Select to open Pictures & Videos.

### The Camera [Video] screen



The Recording Status indicator **REC** blinks while video recording is in progress.

### The Camera [Picture Theme] screen



Displays the current and total number of photos that can be taken using the selected template.



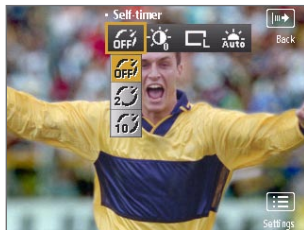

## Quick Settings Menu

The Quick Settings Menu provides a quick way of adjusting some camera settings. Select  on the screen to open the menu.



**Note** The available settings on the menu depend on the Capture mode selected.

Use the **NAVIGATION WHEEL** to select the setting you want to change. Press **NAVIGATION** up or down to go through the options per setting, then press **CENTER SELECT** to choose the option.

Icon	Function
	Select the Self-timer option for capturing images: <b>Off</b> , <b>2 seconds</b> , or <b>10 seconds</b> . Selecting <b>2 seconds</b> or <b>10 seconds</b> delays the capturing by the specified time after you press <b>CENTER SELECT</b> .
	Increase or decrease the brightness level. When selected, press <b>NAVIGATION</b> up or down to adjust the brightness.
	Only available in Picture Theme mode. Allows you to select a template to use for Picture Theme mode.
	Choose the resolution to use when capturing video or images.
	Specify the white balance setting such as <b>Auto</b> , <b>Daylight</b> , <b>Night</b> , <b>Incandescent</b> , and <b>Fluorescent</b> to suit the lighting environment.

## Use zooming

Before capturing a still image or a video clip, you can first zoom in to make the object in focus move closer, and you can zoom out to make the object move farther away. In all capture modes, press **NAVIGATION** up on your phone to zoom in, **NAVIGATION** down to zoom out.

The camera zoom range for a picture or video depends on the capture mode and capture size. Also, please note the capture sizes available for certain capture formats also vary from one capture mode to another.

**Tip** To know if zooming is possible for the selected resolution and/or format, check if the zoom images (i.e. the arrows and trees) on the left side of the screen appear or not. If you do not see these images, zooming is not possible.

## Quick Send

Quick Send lets you quickly send photos you have taken using the phone camera to your online T-Mobile album or journal account or a contact via e-mail or Picture Message.

**Note** Quick Send is only available in Photo mode. When capturing video and Quick Send is enabled, the Review screen appears after you stop capturing. See "The Review screen" below for details.

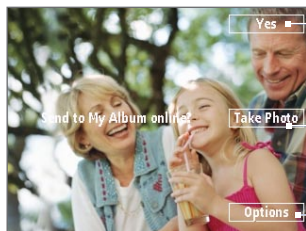

Select (Right **SOFT KEY**) to send the photo to the default destination.

Select (**CENTER SELECT** key) to take another photo without sending the current photo.

Select (Left **SOFT KEY**) to open the Quick Send options screen.

### To change Quick Send settings

Quick Send options let you send the photo to another destination, edit the message before you send out the photo, set the photo as a myFaves icon, change the default destination, and more. You can access the Quick Send options by selecting **Options** on the Quick Send screen.

### To change the default destination

1. On the Camera screen, select **Menu > Settings > Quick Send** tab > **Destination > Customized**.

**Note** You must be in the Photo capture mode to be able to see the Quick Send tab.

**Tip** You can also change the default destination on the Quick Send screen by selecting **Options > Change Default Destination > Change**.

2. On the Change screen, select the new destination and select **Select**.
3. On the confirmation screen, select **OK** to change the default destination.

### To disable Quick Send

By default, the Quick Send screen appears after you have taken a photo using one of the supported capture modes.





To disable the Quick Send screen, on the Camera screen, select **Menu > Settings > Quick Send** tab > **Quick Send > Off**.

**Note** When Quick Send is disabled, the Review screen will appear after capturing a photo or video.

## The Review screen



After capturing a photo or video, you will be presented with options that you can do with the captured media file.

**Note** The Review screen only appears after a photo or video is captured when Quick Send is disabled or the capture mode is not supported by Quick Send.

Icon	Function
	Select to go back to the Camera screen.
	Select to delete the captured image or video clip.
	Select to send the captured image or video clip to someone via e-mail or Picture Message.
	Select to switch to Pictures & Videos to show the still image, or switch to Windows Media® Player to play back the video clip.
	Select to associate the photo to a selected contact. ( <b>Contacts Picture mode</b> )

**Note** After you have taken photos in **Sports** mode, the total number of consecutive shots is shown at the lower right corner of the Review screen. Press **NAVIGATION** up or down to browse through the sequence of photos.

## Camera Capture and Advanced Settings

Select  >  on the Camera screen to open the Camera settings screen where you can add a picture effect, change the quality, customize capture settings, adjust camera display properties, and more.

Press **CENTER SELECT** to open the options associated with the item.

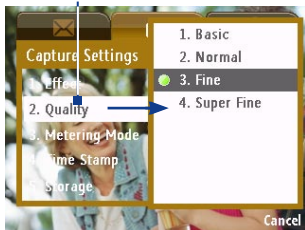

Indicates that there is another page. Scroll the **NAVIGATION WHEEL** to go to the next page.

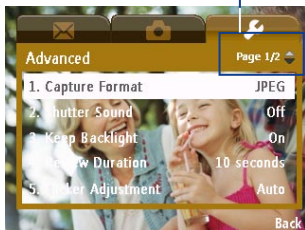

### To change Capture Settings or Advanced settings

1. Press **NAVIGATION** left/right to select either the **Capture Settings** or **Advanced** tab.
2. Press **NAVIGATION** up/down to choose the setting the change. When a setting is selected, press **CENTER SELECT** to see the available options for the particular setting.
3. Choose the option you want, then press **CENTER SELECT**.
4. Select **Back** to close the Settings screen.



## 9.2 Pictures & Videos

The Pictures & Videos program allows you to view and manage photos, animated GIFs, and video files on your phone.

### Copy pictures, animated GIFs and video clips

You can copy pictures and animated GIFs from your PC or a storage card to the My Pictures folder, and copy video clips to the My Videos folder on your phone.

For more information about copying files from your PC to your phone, see Windows Mobile Device Center or ActiveSync Help on your PC.

**Note** You can also copy pictures and video files from your PC to your phone using a memory card. Insert the memory card into the memory card slot on your phone, and then copy them from your PC to the folder you created on the memory card.

### View media files

1. On the Home screen, select **Start > Pictures & Videos**.
2. Select a media file and select **View** (if picture or GIF animation) or **Play** (if video file) to view or play back the file.

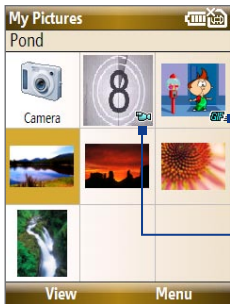

This icon  indicates that the file is a GIF animation file. Select **View** to play back the file.

This icon  indicates that the file is a video file. Select **Play** to play back the file in Windows Media® Player Mobile.

**Note** If you cannot find the media file in the default My Pictures folder, select **Menu > Folders > My Device** to go to other folders.

## Pictures & Videos menu

Select a media file onscreen and select **Menu** to open a list of options that you can do with the selected media file.

You can choose to send the selected media file via one of your messaging accounts, beam it to another device, play the pictures as a slide show, send the picture to your Windows Live MySpace account, and more.

Select **Options** to customize picture settings and slide show playback preferences.

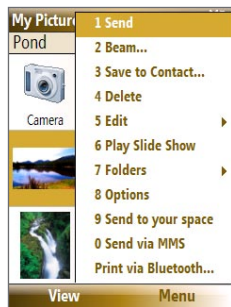

**Note** The available menu options depend on the selected media file.

When viewing a picture file, select **Menu > Use as Home Screen** to set the picture as your Home Screen background. You can also do minor touch ups to the picture such as rotate and crop by selecting **Menu > Edit**.

## Send photos to your Windows Live Space

If you created your own Live Space, you can send pictures from your phone to your Live Space.

### To upload a picture to your Live Space

1. On the Home screen, select **Start > Pictures & Videos**.
2. Select a picture then select **Menu > Send to your space**.



After sending a picture to your Live Space, you can use Internet Explorer® to sign into your Live Space and check whether the picture has been successfully uploaded.

### To go to your Live Space on your phone

1. On the Home screen, select **Start > Internet Explorer**.
2. In Internet Explorer®, select **Menu > Address Bar**. In the address bar, enter "**http://spaces.live.com**" then select **Go**.
3. On the Mobile Live Space's Web page, select **Sign in**.
4. Enter your **E-mail** and **Password** and select **Log In**.
5. On the next Web page, select **Your space**.
6. Wait for your Live Space to be loaded in Internet Explorer®, then select the sharing home page of your Live Space. You will see the picture here.

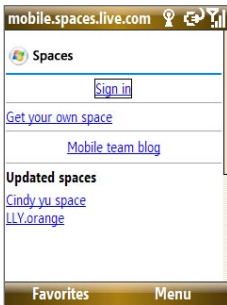

Sharing home page of Live Space link



Uploaded picture

### To go to your Live Space on your computer

1. Open Internet Explorer® on your PC.
2. On the address bar, enter “<http://spaces.live.com>” then press ENTER.
3. In the Windows Live Spaces Web site, click **Your space**.
4. Move the mouse pointer over to your Windows Live ID, then click **Sign In**.

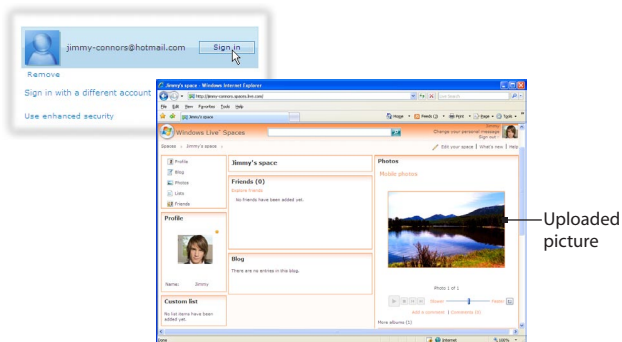

## 9.3 Windows Media® Player Mobile

You can use Windows Media® Player Mobile to play digital audio and video files that are stored on your phone or on a network, such as on a Web site.

### To open Windows Media Player Mobile

Select **Start > Windows Media**.

### About the controls

By default, these hardware buttons are assigned to Windows Media® Player Mobile functions.

**Tip** To change the assigned hardware buttons, on the Playback screen, select **Menu > Options > Buttons**.

To	Press
Play or pause	CENTER SELECT
Skip to a previous file	NAVIGATION left
Skip to the next file	NAVIGATION right
Increase the volume	NAVIGATION up
Decrease the volume	NAVIGATION down
Turn the sound on or off quickly (mute)	#
Switch to full screen during video playback	0
Change rating	*
Fast-forward a file	NAVIGATION right (hold)
Rewind a file	NAVIGATION left (hold)

## About the screens and menus

Windows Media® Player Mobile has three primary screens:



### Playback screen

The default screen that displays the playback controls and the video window.



### Now Playing screen

This special playlist indicates the current file being played and files that are queued up to play next.

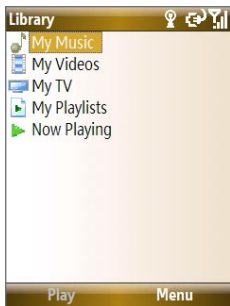

### Library screen

The screen that lets you quickly find your audio files, video files, and playlists.

When you copy new media files to your phone, select **Menu > Update Library** to update the contents of the library.

Select **Menu** to open a list of options that you can do in a particular screen. The commands on this menu vary, depending upon which screen you are viewing.

## About licenses and protected files

Some media files have associated licenses that protect them from being unlawfully distributed or shared.

If you want to copy a protected file from your PC to your phone, use the Windows Media® Player on your PC to synchronize the file to your phone. This will ensure that the license is copied along with the protected file. For more information about synchronizing files to your phone and other mobile devices, see the Windows Media® Player Help.

**Note** You can view the protection status for a file by checking its file properties (**Menu > Properties**).

## Synchronize video and audio files

Install Microsoft Windows Media® Player 11 on your PC to synchronize digital media files from your PC to your device. This ensures that protected files and album art (for skins) are copied to your phone correctly.

### To synchronize content to your phone automatically

1. On your PC, start Windows Media® Player and then connect your phone to your PC.
2. In the Device Setup Wizard, select **Yes, Search my computer now**.  
**Note** If you have previously searched your PC for media files using Windows Media Player, this step is skipped.
3. The Device Setup Wizard then shows the device name (or shows “Storage Card” if you have inserted one on your phone). Click **Finish**.
4. On the leftmost pane of Windows Media® Player, right-click your phone then click **Set Up Sync**.

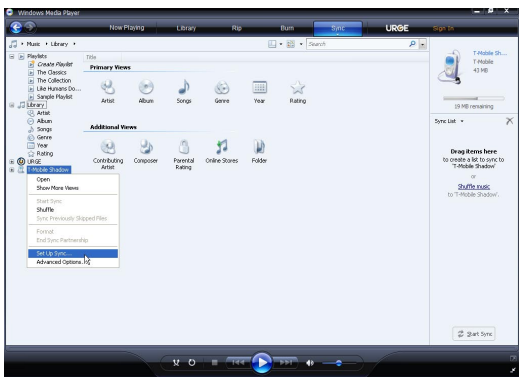

**Note** You can also sync your storage card if you have one installed on your phone. To set up media synchronization, right-click **Storage Card** then click **Set Up Sync**.

5. On the Device Setup dialog box, select **Sync this device automatically**.
6. If you created your own playlists, select your desired playlist(s) from the list box at the left, then click **Add** to add them to the list of playlists to sync on the right.

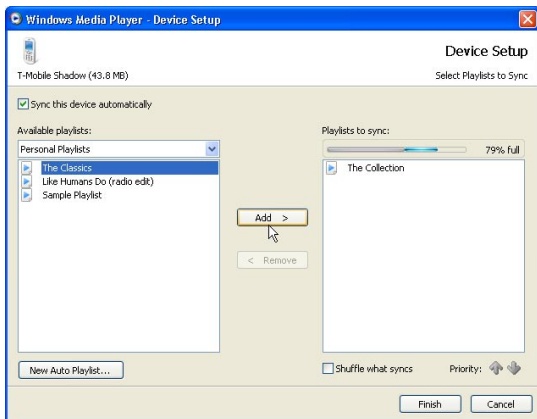

### 7. Click **Finish**.

The files begin synchronizing to your phone. The next time you connect your phone to your PC while Windows Media® Player is running, synchronization will start automatically.

See “Play media” for instructions on how to play media files.

### To synchronize content manually to your phone

1. If you have not set up synchronization between your phone and PC, follow steps 1 to 3 in “To synchronize content to your phone automatically.”
2. Click the **Sync** tab on the Windows Media® Player. Select a Playlist or a Library on the left panel of the Windows Media® Player.
3. From the content list, drag files you want to sync to your phone to the right panel of the Windows Media® Player.



#### 4. Click **Start Sync** to start copying files to your phone.

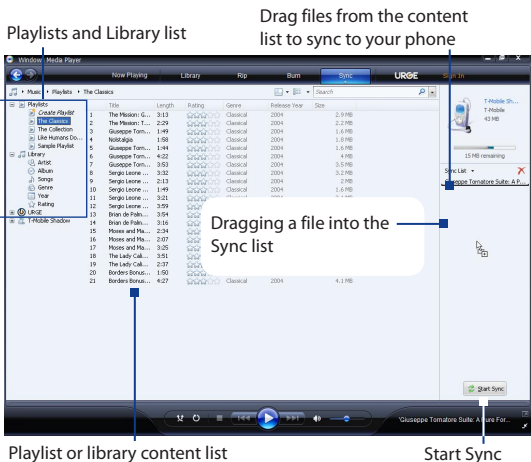

#### Notes

- Use Windows Media® Player 11 or later on your PC to synchronize (copy) media files to your phone.
- Audio files copy faster if Windows Media® Player is configured to automatically set the quality level for audio files copied to your phone. For more information, see the Windows Media® Player Help.

### Play media

Use the library to find and play songs, videos, and playlists that are stored on your phone or storage card.

#### To update the Library

You need to update the Library in Windows Media® Player Mobile first before you can view and play media on your device.

1. Select **Start > Windows Media**.
2. On the Library screen, select **Menu > Update Library** to update the library list.

**Tip** If you do not see the Library screen when you open Windows Media® Player Mobile, select **Menu > Library** to go to the Library.

3. Select **Done**.

### To play video and audio files on your phone

1. Select a category (for example, **My Music** or **My Playlists**).
2. Select the item that you want to play (such as a song, album, or artist name), and then select **Play**.

**Note** To play a file that is stored on your phone but is not in a library, on the Library screen, select **Menu > Open File**. Select the item that you want to play (such as a file or a folder), and select **Play**.

## Playlists

A playlist is a list of digital media files that play in a specified order. By using playlists, you can group audio and video files together for convenient playback.

In Windows Media® Player on your PC, you can create playlists and synchronize them with your phone.

In Windows Media® Player Mobile on your phone, playlists are available in the Library under the My Playlists category. There is also a temporary playlist, called Now Playing, which lists the currently playing file, as well as any files that have been queued up to play next. You can create a new playlist on your device by saving the current Now Playing playlist and by giving it a new name.

### To save a new playlist

1. If you are not on the Library screen, select **Menu > Library**.
2. Select a category (for example, My Music or My Playlists).
3. Select a media file that you want, then select **Menu > Queue Up**. This adds the file to the Now Playing list.

Repeat this step until you have added all desired media files to the Now Playing list.

**Note** You cannot select multiple files simultaneously.

4. After adding the media files, select **Menu > Now Playing**.
5. On the Now Playing screen, select **Menu > Save Playlist**.

6. Enter the playlist name then select **Done**.
7. To play back the playlist you created, select My Playlists in the Library, select your playlist, then select **Play**.

## Troubleshooting

For more information, see the Troubleshooting Windows Media® Player Mobile page at the Microsoft Web site (<http://www.microsoft.com/windows/windowsmedia/player/windowsmobile/troubleshooting.aspx>).

## 9.4 Java Applications

MIDlets are Java™-based applications that can run on mobile devices. Your phone supports Java 2 Edition, J2ME™. Java allows you to download Java-based applications, such as games and tools that are specifically designed for mobile devices. Java gives you the flexibility of installing and managing additional J2ME applications from the Internet.

### Install and run MIDlets/MIDlet suite

#### To install MIDlets from the Internet

1. On the Home screen, select **Start > Applications > Java Applications**. The Java screen appears.
2. Select **Menu > Install > Browser** to open Internet Explorer® Mobile.
3. Locate the MIDlet/MIDlet suite while connected to the Internet.
4. Select the MIDlet/MIDlet suite to download.
5. To start installing the MIDlet/MIDlet suite, select **Yes**.
6. Select **Done** to confirm the installation.

#### Notes

- You can cancel the installation at any time.
- Downloaded MIDlets/MIDlet suites will be automatically saved in the My Documents folder.

### To install MIDlets from a PC

You can install the MIDlets/MIDlet suites on your phone from a PC using the USB sync cable, or Bluetooth. MIDlets copied to your phone using Bluetooth or e-mail attachments are automatically saved in the My Documents folder.

### To install MIDlets from a local folder

1. On the Home screen, select **Start** > **Applications** > **Java Applications**. The Java screen appears.
2. Select **Menu** > **Install** > **Local Files** to install the MIDlets on your phone.
3. Select the MIDlet/MIDlet suite from the list by using the **NAVIGATION WHEEL**.
4. Select **Install**.
5. Select a folder where to install the MIDlet, then select **OK**.



### To run MIDlets/MIDlet suites on your phone

1. On the Home screen, select **Start** > **Applications** > **Java Applications**. The Java screen appears.
2. Select a MIDlet/MIDlet suite from the list by using the **NAVIGATION WHEEL**.
3. Press **CENTER SELECT** or select **Launch** to run the MIDlet.

## Manage MIDlets/MIDlet suite

You can organize the MIDlets/MIDlet suites into folders. You can also uninstall, move or rename MIDlets/MIDlet suites.

### To uninstall a MIDlet

Before you uninstall a MIDlet/MIDlet suite, make sure that it is not running.

1. On the Java screen, select the MIDlet/MIDlet suite by using the **NAVIGATION WHEEL**.
2. Select **Menu > Actions > Uninstall**.
3. Select **OK** to confirm.

**Note** On the Java screen, select **Menu > Uninstall All** to uninstall all MIDlets.

### To update a MIDlet/MIDlet suite

Java will search for updates for the selected MIDlet/MIDlet suite where it was installed from before.

1. On the Java screen, select the MIDlet/MIDlet suite by using the **NAVIGATION WHEEL**.
2. Select **Menu > Actions > Update**. Java then searches for updates.
3. Select **Yes** or **No** depending on the update scenario.

### To change the display name of a MIDlet or folder

1. On the Home screen, select **Start > Applications > Java Applications**. The Java screen appears.
2. Select a MIDlet/MIDlet suite or folder by using the **NAVIGATION WHEEL**.
3. Select **Menu > Actions > Rename**.
4. Enter a new name for the MIDlet then select **Save**.

### To move a MIDlet or folder to another location

1. On the Java screen, select the MIDlet/MIDlet suite or folder by using the **NAVIGATION WHEEL**.
2. Select **Menu > Actions > Move**.
3. Select the location where you want to move the MIDlet or folder to then select **OK**.

**Tip**      Select **Menu > New Folder** to create a new folder.

### To view protection information of a MIDlet

If the MIDlet/MIDlet suite is protected by DRM (Digital Rights Management), there are some restrictions on how you can use the MIDlet/MIDlet suite. DRM is a technology used by publishers to control access to digital data.

1. On the Java screen, select the MIDlet/MIDlet suite or folder by using the **NAVIGATION WHEEL**.
2. Select **Menu > Actions > Protection**.
3. Choose the information you want to view and select **Select**.

# Chapter 10

## Using Other Applications

**10.1 Microsoft® Office Mobile**

**10.2 Microsoft® Office Word Mobile**

**10.3 Microsoft® Office Excel® Mobile**

**10.4 Microsoft® Office PowerPoint® Mobile**

**10.5 Microsoft® Office OneNote® Mobile**

**10.6 Adobe® Reader® LE**

**10.7 Speed Dial**

**10.8 Voice Command**

## 10.1 Microsoft® Office Mobile

**Microsoft® Office Mobile** consists of three applications that let you view and edit Microsoft documents. These 3 applications are:

- **Microsoft® Office Word Mobile** lets you view and edit Microsoft Word documents and text files.
- **Microsoft® Office Excel® Mobile** lets you view and edit Microsoft Excel worksheets.
- **Microsoft® Office PowerPoint® Mobile** lets you view Microsoft PowerPoint slides.
- **Microsoft® Office OneNote® Mobile** lets you easily create notes with audio and images.

To learn how to copy files, see “Managing and Backing Up Files” in Chapter 4.

## 10.2 Microsoft® Office Word Mobile

Microsoft® Office Word Mobile gives you editing and viewing capabilities for your Word documents and text files.

### To open Word Mobile

Select **Start > Office Mobile > Word Mobile**.

**Note** Word Mobile does not fully support some features of Microsoft Word. Some data and formatting may be lost when you save the document on your phone.

### View documents

#### To open a document

1. In Word Mobile, select **Menu** and choose the location where the **.doc**, **.rtf**, or **.txt** file is saved.
2. Locate the file you want to open and select **Select**.

**Note** You can only open one document at a time. You must close the opened document first before you can open another document.



### To change the zoom ratio

Select **View** and then on the menu, select the zoom ratio to use.

Select **View > Wrap to Window** to adjust the text flow so that the text wraps based on the screen size. This way, you do not need to scroll right to read long paragraphs or sentences.

**Note** Text in tables cannot be wrapped.

### To change scrolling preference

Select **Menu > Scroll Up/Down** and then select **By Page** or **By Line**.

### To find a word in a document

1. Select **Menu > Find**.
2. Type in the word you want to find in **Find What**. Select **Match case** and/or **Whole words only** if needed.
3. Select **Find**.

### To close the document

Select **Menu > Close File**.

## Edit and send documents

In order to edit Word documents or text files, you need to switch to Edit mode. To switch to Edit mode, select **Menu > Edit**.

### To type words into the document

1. In the document, use the **NAVIGATION WHEEL** to position the cursor where you want to insert the text.  
**Tip** Select **Menu > Format** to change the font format. You can use **Bold**, **Italic**, **Underline**, and **Highlight**.
2. Type in the text using the QWERTY keyboard.  
**Tip** If you are using a formatting style and you want to revert to no formatting style, select **Menu > Format** and select the formatting style you are using from the menu.

**To save the document**

1. Select **Menu > File > Save As**.
2. Type in the **Name** you want to use for the edited document and select the **Location** where you want to save the document.
3. Select **Save**.

**To send the document through e-mail**

1. Select **Menu > File > Send**.
2. In the Messaging screen, select the E-mail account you want to use to send the document and select **Select**.
3. In the e-mail, the file is automatically appended as an attachment.
4. Enter the recipient name and select **Send**.

## 10.3 Microsoft® Office Excel® Mobile

Microsoft® Office Excel® Mobile gives you editing and viewing capabilities for your Excel worksheets.

**To open Excel Mobile**

Select **Start > Office Mobile > Excel Mobile**.

**Note** Excel Mobile does not fully support some features such as Microsoft Excel. Some data and formatting may be lost when you save the workbook on your phone.

### View worksheets

**To open a file**

1. In Excel Mobile, select **Menu** and choose the location where the **.xls** file is saved.
2. Locate the file you want to open and select **Select**.

**Note** You can only open one worksheet at a time. You must close the opened worksheet first before you can open another worksheet.

By default, the worksheet opens in Full Screen mode, to change the view mode, press the left **SOFT KEY** (to show the View menu) and select **View > Full Screen**.

### To view the contents of a cell

There are times that the text in a cell cannot be fully displayed onscreen. To view the text in the cell in its entirety, select the cell and then select **View > Cell Text**.

### To immediately view an area in the worksheet

1. In the worksheet, select **View > Overview**.
2. Use the **NAVIGATION WHEEL** to move the rectangular marquee to the area you want to view.
3. Press **CENTER SELECT**.

### To use Freeze Pane

1. Select the cell that is after and below the row and column you want to freeze.  
For example, if you want to freeze **column E** and **row 4**, you should select cell **F5**.
2. Select **View > Freeze Panes**. To unfreeze the panes, select **View > Unfreeze Panes**.

### To change the zoom ratio

Select **View > Zoom** and then select the zoom ratio to use.

### To switch to another worksheet

If your Excel file has multiple worksheets, you can go to a different worksheet by selecting **View > Sheet** and then select the worksheet you want to view.

### Edit and send worksheets

In order to edit Excel worksheets, you need to switch to Edit mode. To switch to Edit mode, select **Menu > Edit**.

### To edit the cell text

1. Select the cell whose text you want to edit and select **Menu > Edit > Cell Text**.
2. Type in the text and select **Done**.

### To delete the cell content

Select the cell whose content you want to delete and select **Menu > Edit > Clear Cell**.

**Tip** You can select multiple cells by selecting **Menu > Select** and then choosing what to select in the worksheet.

### To edit the cell range of a defined name

If your worksheet contains defined names created in Microsoft Excel on the PC, you can edit the cell range of the defined name.

1. Select **Menu > Edit > Define Name**.
2. In **Range Name**, select the name whose cell range you want to change.
3. In **Refers to**, type in the new cell range.
4. Select **Done**.

### To delete cells

Select the cell you want to delete and select **Menu > Edit > Delete Cells**.

**Tip** You can select multiple cells to delete by selecting **Menu > Select** and then choosing what to select in the worksheet.

### To copy and paste cell contents

1. Select the cell(s) you want to copy and then select **Menu > Edit > Copy**.

**Tip** You can select multiple cells to delete by selecting **Menu > Select** and then choosing what to select in the worksheet.

2. Select the cell(s) where you want to copy the cell contents to and select **Menu > Edit > Paste**.

### To insert a row or column

Select the cell where you want to insert a row or column and then select **Menu > Insert > Row** or **Column**. If you insert a row, the row will be inserted above the selected cell; if you insert a column, the column will be inserted at the left of the selected cell.

**Tip** You can also shift the contents of a row or column. To shift, select the cell you want to shift and select **Menu > Insert > Shift Right** or **Shift Down**.

**To go to a cell**

Select **Menu > Tools > Go To** and then enter the **Cell reference or name**.  
Select **OK**.

**Tip** You can also sort and find text in the worksheet by selecting **Menu > Tools > Sort** or **Find**.

**To undo and redo an action**

Select **Menu > Undo [Action]** or **Redo [Action]**.

**To save the worksheet**

1. Select **Menu > File > Save As**.
2. Type in the **Name** you want to use for the edited worksheet and select the **Location** where you want to save the worksheet.
3. Select **Save**.

**To send the document through e-mail**

1. Select **Menu > File > Send**.
2. In the Messaging screen, select the E-mail account you want to use to send the worksheet.
3. In the e-mail, the file is automatically appended as an attachment.
4. Enter the recipient name and select **Send**.

## 10.4 Microsoft® Office PowerPoint® Mobile

Microsoft® Office PowerPoint® Mobile gives viewing capabilities for your PowerPoint presentations.

### To open PowerPoint Mobile

Select **Start > Office Mobile > PowerPoint Mobile**.

### To open a file

1. In PowerPoint Mobile, select **Menu** and choose the location where the **.ppt** file is saved.
2. Locate the file you want to open and select **Select**.

### To go through the slides of the presentation

Press **NAVIGATION** right to go forward in the presentation; press **NAVIGATION** left to go back to the previous action or slide of the presentation.

You can also go to a particular slide in your presentation by pressing the right **SOFT KEY** (to show the Menu) and selecting **Menu > Go to Slide** then choosing the slide to go to.

### To view a custom show

You can view custom shows that you created on Microsoft PowerPoint on your computer on your phone.

1. Press the right **SOFT KEY** to show **Menu**.
2. Select **Menu > Custom Show** and then select the custom show you want to view on the list.

### To zoom in on a slide

1. Press the right **SOFT KEY** to show **Menu**.
2. Select **Menu > Zoom In**.

**Note** You cannot go the next or previous slide when you zoom in. You need to zoom out first to be able to go to the next or previous slide. To zoom out, select **Menu > Zoom Out**.

**To set PowerPoint Mobile preferences**

1. Press the right **SOFT KEY** to show **Menu**.
2. Select **Menu > Options**.
3. Set the **Orientation** and **Playback options** and select **Done**.

**To show links in a slide**

You can show and activate hyperlinks in slides that you created on Microsoft PowerPoint on your phone.

1. Press the right **SOFT KEY** to show **Menu**.
2. Select **Menu > Show Links**.
3. Press **CENTER SELECT** to activate the hyperlink. If there is more than one hyperlink on the slide, use **NAVIGATION WHEEL** to select the hyperlink you want to activate.

**To end the presentation**

Press the right **SOFT KEY** (to show End) and select **End**.

## 10.5 Microsoft® Office OneNote® Mobile

Microsoft Office OneNote Mobile lets you easily create notes with audio and images. Create the notes in your phone, then synchronize them with your PC to keep your OneNote files up-to-date.

**Note** You need an ActiveSync partnership between your computer and phone and Microsoft Office OneNote on your computer to synchronize OneNote files.

### To open OneNote Mobile

Select **Start > Office Mobile > OneNote Mobile**.

OneNote Mobile opens with the list of notes in your phone. Select **Menu** to let you rename a file and set the sort order of the list.

### To create a new OneNote file

1. In OneNote Mobile, select **New**.
2. Enter the note by typing in text or by adding pictures or audio. You can do the following when creating your note.
  - To add an audio file into the note, select **Menu > Insert Recording**.
  - To take a picture and add it into the note, select **Menu > Take Picture**.
  - To add a picture from file into the note, select **Menu > Insert Picture**.
  - To create a bulleted or numbered list, select **Menu > List > Numbered** or **Bulleted**.
  - To change the text format, select **Menu > Format**.

**Tip** If you are using a formatting style and you want to revert to no formatting style, select **Menu > Format** and select the formatting style you are using from the menu.

3. After completing the note, select **Done**.



## 10.6 Adobe® Reader® LE

**Adobe® Reader® LE** lets you view Portable Document Format (PDF) files. When you open a password-protected PDF file, you will be prompted to enter the password before the file can be opened.

### To open a PDF file on your phone

1. Select **Start > Applications > Adobe Reader LE**.
2. Select **Open**.
3. Browse to a folder and select the PDF file you want to open.

**Note** To open another PDF file, select **Open > Menu > Browse For File**. You can also open a PDF file from File Explorer by selecting it.

### To navigate through a PDF file

You can do any of the following:

- Use the NAVIGATION CONTROLS to scroll through the pages.
- Select **Menu > Go To** and select an option to go to a specific page in the PDF file.

While reading a PDF file, select **Menu** to open a list of options that lets you zoom in, directly go to a bookmark, find text in the file, and more.

## 10.7 Speed Dial

You can create speed dial entries for frequently-called numbers or frequently-accessed items so you can dial a number or access an item by pressing a single key.

### To create a speed dial entry for a contact

1. On the Home screen, select **Start > Contacts**.
2. Select a contact.
3. Press **CENTER SELECT** to view the contact details.
4. Select the desired phone number and select **Menu > Add to Speed Dial**.

5. Enter appropriate details in Name, Value, and Keypad assignment .
6. Select **Done**. To quit at any time during this process, select **Menu > Cancel**.

### To create a speed dial entry for an item

1. On the Home screen, select **Start** then choose (just highlight) the item you want.
2. Select **Menu > Add Speed Dial**.
3. Enter details in Name, Value, and Keypad assignment.
4. Select **Done**. To quit at any time during this process, select **Menu > Cancel**.

**Note** The first speed dial location is generally reserved for your voice mail. Speed Dial uses the next available location by default. If you want to place a number in a location that is already used, the new number replaces the existing number.

### To retrieve a voice mail message

On the Home screen, press and hold  to access your voice mailbox, and follow the prompts to retrieve your messages.

### To make a call or launch a program using Speed Dial

If you have assigned a speed dial (for example, the second location) to a contact or a program in Speed Dial, you can simply press and hold the 2 key on the phone keyboard to dial the contact's number or open the program.

### To delete a speed dial entry

1. On the Home screen, select **Start > Speed Dial**.
2. Select the desired entry and select **Menu > Delete**.

## 10.8 Voice Command

Voice Command lets you call your contacts, open applications, play back music, and get calendar information just by using your voice.

Voice Command only responds to a set of predefined commands, you cannot create your custom commands in Voice Command.

To learn more about the commands that you can use, select **Start > Voice Command > Menu > Help**.

### To set the Voice Command button

You need to set a button on your phone as the Voice Command button for you to enable and disable it. The default button to activate Voice Command is to press and hold the **SHORTCUT KEY**.

When Voice Command is activated, the  icon will appear on top-right corner of the screen.

1. Select **Start > Voice Command**.
2. In **Voice Button**, select the button you want to use and select **Done**.

You can set other options in the Voice Command screen. To learn about the different options, consult the Voice Command help.

### To call a contact

1. Hold the phone a few inches away from your mouth.
2. Press and hold the **SHORTCUT KEY** to activate Voice Command.
3. In a clear voice, say "Call [Contact Name]."
4. Voice Command will confirm with you the contact you want to call. After the Voice Command confirmation, say "Yes" or "Correct."  
**Note** If Voice Command is wrong about the contact to call, say "No" or "Incorrect" to try again.
5. The phone starts to call the contact.

### To show the contact card of a contact

This will only show contacts that are saved on the phone.

1. Hold the phone a few inches away from your mouth.
2. Press and hold the **SHORTCUT KEY** to activate Voice Command.

3. In a clear voice, say “Show [Contact Name]” or “Lookup [Contact Name].”

### To request information from your calendar

1. Hold the phone a few inches away from your mouth.
2. Press and hold the **SHORTCUT KEY** to activate Voice Command.
3. In a clear voice, say the information you want to retrieve. For example, “What’s my next appointment?” or “What’s my next meeting?”

Consult the Voice Command help file to learn the other commands that you can use to retrieve other Calendar information.

### To open a program

1. Hold the phone a few inches away from your mouth.
2. Press and hold the **SHORTCUT KEY** to activate Voice Command.
3. In a clear voice, say “Open [Program Name].”

**Tip** You can also say “Show [Program Name]” or “Start [Program Name]” to open programs. Use the phrase that you are most comfortable with.

### To request phone status information

1. Hold the phone a few inches away from your mouth.
2. Press and hold the **SHORTCUT KEY** to activate Voice Command.
3. In a clear voice, say the phone status information you want to retrieve. For example, say “What time is it?” or “What date is it?”

Consult the Voice Command help file to learn the other commands that you can use to retrieve other phone status information.

### To get help in using Voice Command

1. Hold the phone a few inches away from your mouth.
2. Press and hold the **SHORTCUT KEY** to activate Voice Command.
3. In a clear voice, say “Help.”

### To use Voice Command with a Bluetooth headset

Activate Voice Command from your Bluetooth headset by pressing the voice dial button on the Bluetooth headset.

For more information about Voice Command, please go to <http://www.microsoft.com/windowsmobile/voicecommand/default.mspx>

# Appendix

**A.1 Specifications**

**A.2 Regulatory Notices**

## A.1 Specifications

### System information

<b>Processor/Chipset</b>	• TI's OMAP™ 850 200 MHz
<b>Memory</b>	<ul style="list-style-type: none"> <li>• ROM: 256 MB (Standard)</li> <li>• RAM: 128 MB DDR</li> <li>• Free memory: XXX MB</li> <li>• Available program storage: XXX MB (variable, depending on installed applications)</li> </ul> <p>(The first two figures above are the total ROM and RAM memory available for use and storage. Since the memory is shared by the Operating System, applications, and data, the actual available memory is less than what is written).</p>
<b>Operating system</b>	Windows Mobile® 6 Standard

### Display

<b>Type</b>	2.6" Transmissive QVGA LCD with white LED back light
<b>Resolution</b>	320 x 240 dots resolution at 65K Colors

### GSM/GPRS/EDGE Quad-band module

<b>GSM 850</b>	824 ~ 849, 869 ~ 894 MHz
<b>GSM 900</b>	880 ~ 915, 925 ~ 960 MHz
<b>GSM 1800</b>	1710 ~ 1785, 1805 ~ 1880 MHz
<b>GSM 1900</b>	1850 ~ 1910, 1930 ~ 1990 MHz

### Camera module

<b>Type</b>	2 Megapixel CMOS
<b>Resolution</b>	<ul style="list-style-type: none"> <li>• UXGA: 1600 x 1200</li> <li>• SXGA: 1280 x 1024</li> <li>• VGA: 640 x 480</li> <li>• QVGA: 320 x 240</li> <li>• QQVGA: 160 x 120</li> </ul>

**Connections**

<b>I/O port</b>	HTC ExtUSB™ : an 11-pin mini-USB and audio jack in one  (ExtUSB is a proprietary connection interface that is trademarked by HTC)
<b>Bluetooth</b>	V 2.0 without EDR, Class 2 transmit power
<b>Wi-Fi</b>	IEEE 802.11b/g compliant, Internal WLAN antenna

**Audio**

<b>Headphone</b>	AAC/AMR/WMA/WAV/MP3 codec
<b>Ring tone</b>	<ul style="list-style-type: none"><li>• Software polyphonic and standard MIDI format 0 and 1 (SMF)/SP MIDI</li><li>• MP3, AAC, AAC+, WMA, WAV, and AMR-NB</li></ul>

**Physical**

<b>Dimension</b>	4.05 inches (L) x 2.05 inches (W) x 0.6 inches (T)
<b>Weight</b>	0.23 lbs with battery pack

**Controls and lights**

<b>Navigation</b>	Navigation wheel with 4-way navigation/Center Select Key
<b>Buttons</b>	<ul style="list-style-type: none"><li>• Volume buttons</li><li>• Left and Right Softkeys</li><li>• Home screen</li><li>• Back to previous screen</li><li>• Send (start call/answer call)</li><li>• End call/Power</li><li>• Side Button (Customizable)</li><li>• Camera</li><li>• 20-key QWERTY keyboard</li></ul>

**Lights**

- Event notification
  - Charge status
  - GSM/GPRS/EDGE signals
  - Bluetooth connection
- 

**Expansion slot****microSD slot**microSD memory card

---

**Power supply****Battery**

Li-Polymer 920 mAh removable, rechargeable battery

**Talk time**

Up to 7 hours

**Standby**

Up to 175 hours

**AC adapter**

- AC input/frequency: 100 ~ 240 AC, 50/60Hz
- DC output: 5V and 1A



## A.2 Regulatory Notices

### Regulatory Agency Identifications

For regulatory identification purposes, your product is assigned a model number of **PHOE100**.

To ensure continued reliable and safe operation of your phone, use only the accessories listed below with your **PHOE100**.

The Battery Pack has been assigned a model number of **KII0160**.

This product is intended for use with a certified Class 2 Limited Power Source, rated 5 Volts DC, maximum 1 Amp power supply unit.

### Federal Communications Commission Notice

This device complies with part 15 of the FCC Rules. Operation is subject to the following two conditions: (1) This device may not cause harmful interference, and (2) this device must accept any interference received, including interference that may cause undesired operation.

This equipment has been tested and found to comply with the limits for a Class B digital device, pursuant to Part 15 of the FCC Rules. These limits are designed to provide reasonable protection against harmful interference in a residential installation. This equipment generates, uses, and can radiate radio frequency energy and, if not installed and used in accordance with the instructions, may cause harmful interference to radio communications. However, there is no guarantee that interference will not occur in a particular installation. If this equipment does cause harmful interference to radio or TV reception, which can be determined by turning the equipment on and off, the user is encouraged to try to correct the interference by one or more of the following measures:

- Reorient or relocate the receiving antenna.
- Increase the separation between the equipment and receiver.
- Connect the equipment into an outlet on a circuit different from that to which the receiver is connected.
- Consult the dealer or an experienced radio or television technician for help.

- The FCC requires the user to be notified that any changes or modifications made to the device that are not expressly approved by High Tech Computer Corporation may void the user's authority to operate the equipment.

## Safety precautions for RF exposure

Use only original manufacturer-approved accessories, or accessories that do not contain any metal

Use of non-original manufacturer-approved accessories may violate your local RF exposure guidelines and should be avoided.

The exposure standard for wireless mobile phones employs a unit of measurement known as the **Specific Absorption Rate**, or SAR.

For body worn operation, this phone has been tested and meets the FCC RF exposure guidelines when used with the standard accessories supplied or designated for this product. Use of other accessories may not ensure compliance with FCC RF exposure guidelines.

The standard incorporates a substantial margin of safety to give additional protection for the public and to account for any variations in usage.

Normal conditions only ensure the radiative performance and safety of the interference. As with other mobile radio transmitting equipment, users are advised that for satisfactory operation of the equipment and for the safety of personnel, it is recommended that no part of the human body be allowed to come too close to the antenna during operation of the equipment.

## SAR Information

- 1.53 w/kg @ 1g

## Telecommunications & Internet Association (TIA) safety information

### Pacemakers

The Health Industry Manufacturers Association recommends that a minimum separation of six inches be maintained between a handheld wireless phone and a pacemaker to avoid potential interference with the pacemaker. These recommendations are consistent with the independent

research by and recommendations of Wireless Technology Research.

Persons with pacemakers:

- Should ALWAYS keep the phone more than six inches from their pacemaker when the phone is turned ON.
- Should not carry the phone in a breast pocket.
- Should use the ear opposite the pacemaker to minimize the potential for interference. If you have any reason to suspect that interference is taking place, turn your phone OFF immediately.

### **Hearing Aids**

Some digital wireless phones may interfere with some hearing aids. In the event of such interference, you may want to consult your service provider, or call the customer service line to discuss alternatives.

### **Other Medical Devices**

If you use any other personal medical device, consult the manufacturer of your device to determine if they are adequately shielded from external RF energy. Your physician may be able to assist you in obtaining this information.

Turn your phone OFF in health care facilities when any regulations posted in these areas instruct you to do so. Hospitals or health care facilities may be using equipment that could be sensitive to external RF energy.

### **Heed service markings**

Except as explained elsewhere in the Operating or Service documentation, do not service any product yourself. Service needed on components inside these compartments should be done by an authorized service technician or provider.

### **Damage requiring service**

Unplug the product from the electrical outlet and refer servicing to an authorized service technician or provider under the following conditions:

- Liquid has been spilled or an object has fallen into the product.
- The product has been exposed to rain or water.
- The product has been dropped or damaged.
- There are noticeable signs of overheating.
- The product does not operate normally when you follow the operating instructions.

### Other tips and cautions

- Avoid using your phone near metal structures (for example, the steel frame of a building).
- Avoid using your phone near strong electromagnetic sources, such as microwave ovens, sound speakers, TV and radio.
- Avoid using your phone after a dramatic change in temperature.

### WEEE Notice

The Directive on Waste Electrical and Electronic Equipment (WEEE), which entered into force as European law on 13th February 2003, resulted in a major change in the treatment of electrical equipment at end-of-life.

The purpose of this Directive is, as a first priority, the prevention of WEEE, and in addition, to promote the reuse, recycling and other forms of recovery of such wastes so as to reduce disposal.



The WEEE logo (shown at the left) on the product or on its box indicates that this product must not be disposed of or dumped with your other household waste. You are liable to dispose of all your electronic or electrical waste equipment by relocating over to the specified collection point for recycling of such hazardous waste. Isolated collection and proper recovery of your electronic and electrical waste equipment at the time of disposal will allow us to help conserving natural resources. Moreover, proper recycling of the electronic and electrical waste equipment will ensure safety of human health and environment. For more information about electronic and electrical waste equipment disposal, recovery, and collection points, please contact your local city centre, household waste disposal service, shop from where you purchased the equipment, or manufacturer of the equipment.

### RoHS Compliance

This product is in compliance with Directive 2002/95/EC of the European Parliament and of the Council of 27 January 2003, on the restriction of the use of certain hazardous substances in electrical and electronic equipment (RoHS) and its amendments.

# Index

**A**

## Accessibility settings

- confirmation time out 71
- in-call alert volume 71
- multipress time out 71
- system font size 71

## ActiveSync 62

- overview 39
- synchronize 63, 121

## Add and remove programs 72

## Add attachment to message 108

## Adobe Reader 40, 193

## Alarm 70

## Alarm settings 69

## Alerts 69

## Answer/end call 55

## AOL/AIM 106

## Attachments 109

**B**

## Backlight time out 71

## Back up files 74

## Battery

- battery information 47
- battery management 71
- low battery 48

## Beam

- via Bluetooth 151

## Block Picture Message 101

## Bluetooth

- beaming 151
- Bluetooth modem 146
- hands-free headset 149
- modes 147
- overview 147

- partnerships 148
- stereo headset 149
- synchronize 65
- visible 147

## Browsing the Web 143

**C**

## Calculator 39

## Calendar 40, 90

## Call History 40

## Camera 162

- icons and indicators 163
- overview 40
- zoom 166

## Camera settings 168

## Capture formats 163

## Capture modes 162

## Check battery power 48

## Clear Storage 39

## Comm Manager 40, 134

## Company Directory 128

## Compose

- Picture Message 100

## Compose messages 108

## Conference call 56

## Confirmation time out 71

## Connecting to Wi-Fi Network 139

## Connect phone to Internet

- Dial-up 141
- Wi-Fi 135

## Connect phone to private network 142

## Contacts 40, 82

- Beam contact information 84
- Call a contact 83
- Create a new contact 82
- Find a contact 83

- Send contact information via a text message 84
- Send contact information via MMS 84
- View and edit a contact 82

Contacts picture (capture mode) 162

Copy

- contacts to SIM card 85
- files between phone and PC 74
- media files from PC to device 174
- pictures, GIF animation, videos 169
- SIM contacts to phone 85
- sound file to phone 70

Currency setting 68

Customize Home screen 68

## D

Date setting 68

Device lock 77

Dial-up connection 141

Digitally sign messages 130, 131

Digital Rights Management (DRM) 174

Digital signature

- verify 130

Direct Push 122

Display time out 72

## E

E-mail 108

- security 129
- settings (POP3/IMAP4) 112

Emergency call 58

Encrypt messages 130, 131

Enter text and numbers 44

Event notification 69

Excel Mobile 41, 186

Exchange Server 116

- schedule synchronization 122

Exclude e-mail address when replying to all 113

## F

Fetch Mail 124

File Explorer 40, 74

Filter e-mail 108

Find contact

- online 128

Flag your messages 125

Font size (display) 71

Forward message 109

## G

Games 40

GPRS 141

## H

Handango InHand 40

Home screen

- change background 68
- customize 68
- overview 35, 68

HotSpot Settings 42

HotSpot Status 42

## I

IMAP4 106, 107

In-call alert volume 71

Insert a long pause in dialing sequence 58

Insert pause in dialing sequence 58

- Insert SIM Card 32
- Install
  - Microsoft ActiveSync 62
- Install Micro SD Card 34
- Install MIDlets
  - from Internet 179
  - from PC 180
  - locally 180
- Instant Messaging 40
- International call 58
- Internet 135
- Internet Explorer Mobile 40, 143
- Internet Sharing 39, 145

## J

- Java Applications 40, 179

## K

- Keyboard
  - shortcuts 113

## L

- Language/locale setting 68
- LED indicator lights 30
- Licensed and protected media 174
- Live Messenger 155
- Live Search 40, 159
- Live Spaces 170
- Lock the phone 76
- Lock the phone (Password) 77

## M

- Make call
  - from Call History 54
  - from Contacts 53
  - from Home Screen 53
  - from Speed Dial 55
- Managing Meeting Requests 126
- Memory 73
- Messaging 41
  - overview 98
  - Picture messages 100
  - Text messages 99
- Messenger 41, 155
- microSD 29
- MMS Settings 39
- MMS video (capture mode) 162
- Modem
  - Bluetooth modem 146
  - USB modem 145
- Multipress mode 46
- Mute call 57
- myFaves 41, 86

## N

- Number format 68
- Numeric mode 47

## O

- Office Mobile 184
  - Excel Mobile 186
  - PowerPoint Mobile 190
  - Word Mobile 184
- OneNote Mobile 41, 192
- Operating system version 72
- Out-of-office 125



Outlook E-mail 107  
 Owner information 71

## P

Parts and accessories 26  
 Pause in dialing sequence 58

PDF 193

Personal information 71

Phone program 51

Phone specification 72

Photo (capture mode) 162

Pictures & Videos 41, 169

Picture Message 100

- Create and send 100

Picture theme (capture mode) 163

PIN 76

Playlists 178

Play media 178

POP3 106, 107

PowerPoint Mobile 41, 190

Power management 71

Profile 69

Programs 39

- ActiveSync 39
- Adobe Reader 40
- Calculator 39
- Calendar 40, 90
- Call History 40
- Camera 40
- Clear Storage 39
- Comm Manager 40
- Contacts 40, 82
- Excel Mobile 41
- File Explorer 74
- Games 40
- Handango InHand 40

- HotSpot Settings 42

- HotSpot Status 42

- Instant Messaging 40

- Internet Explorer 40

- Internet Sharing 39, 145

- Java 179

- Java Applications 40

- Live Search 40

- Messaging 41, 98

- Messenger 41

- myFaves 41

- OneNote Mobile 41

- Phone 51

- Pictures & Videos 41, 169

- PowerPoint Mobile 41

- Set Up E-Mail 41

- SIM Manager 39, 85

- Speed Dial 41, 193

- T-Mobile HotSpot 42

- Tasks 42, 92

- Task Manager 42, 73

- Video Recorder 40

- Voice Command 42

- Voice Notes 42

- Voice Recorder 39

- Windows Live 43, 153

- Windows Media Player Mobile 43,  
172

- Word Mobile 41

Put call on hold 56

**Q**

- Quick List 44
- Quick Send 166
- Quick Settings Menu 165
- QWERTY keyboard 44

**R**

- Receive
  - call 55
  - Picture Message 101
- Regional settings 68
- Reply
  - Picture Message 101
- Reply message 109, 113
- Reset phone 78
- Restart phone 78
- Review screen 167
- Ring tone 52, 94
- Run MIDlets 180

**S**

- Search for e-mails on the Exchange Server 124
- Secure/Multipurpose Internet Mail Extension (S/MIME) 129
- Securing Wi-Fi Connection 140
- Send
  - email/SMS message 108
  - Picture message 100
- Send and download e-mails 110
- Send appointments 91
- Send messages 108

- Settings 41
- Set up ActiveSync on PC 62
- Set Up E-Mail 41, 106
- Set up Home screen 68
- SharePoint 126
- Share contact information 84
- Shortcuts 113
- Shortcut Key 48
- SIM Manager 39
  - copy contacts to SIM card 85
  - copy SIM contacts to phone 85
  - create SIM contact 85
- Sounds 69
- Speakerphone 57
- Speed Dial 41, 55, 193
- Sports (capture mode) 163
- Start menu 43
- Status Indicators 49
- Stop programs 73
- Swap/switch calls 56
- Synchronize
  - ActiveSync 63
  - change information types 64
  - music and video 66
  - Outlook information with computer 63
  - schedule synchronization with Exchange Server 122
  - via Bluetooth 65
  - Windows Media Player 66
  - Windows Media Player Mobile 174
- System font size 71

**T**

- T-Mobile Address Book 42, 93
- T-Mobile HotSpot 42
  - HotSpot Settings 42
  - HotSpot Status 42
- t-zones 42
- Tasks 42, 92
- Task Manager 42, 73
- Time setting 68
- Troubleshooting
  - sync connection problems 64

**U**

- Using Instant Messaging 102
  - AIM 102
  - ICQ 103
  - Yahoo! 105

**V**

- Verify digital signature 130
- Video (capture mode) 162
- Video Recorder 40
- View and reply to Picture Messages 101
- View your appointments 90
- Visible (Bluetooth) 147
- Voice Command 42
- Voice Notes 42, 95
- Voice Recorder 39, 94
- Volume Control 29

**W**

- Web browser 143
- Wi-Fi 135
- Windows Live 43, 153
- Windows Live Mail 107
- Windows Live Messenger 155
- Windows Live Spaces 170
- Windows Media Player
  - file formats 172
  - menus 173
  - overview 43
  - troubleshooting 179
- Windows Media Player Mobile
  - playlists 178
- Windows Mobile Device Center 61
- Windows Mobile software version 72
- Word Mobile 41, 184

**X**

- xT9 mode 46

**Y**

- Yahoo! 106

**Z**

- Zoom 165

